



Stucchi



2008 Catalog
Unlock The Solution



Customer Service

Satisfaction

Total customer satisfaction is our goal. Please call with any problems or feedback.

How to open an account - Same day approval available

- Fill out the credit application by printing a copy from our website: www.stucchiusa.com
- Fax completed and signed Credit Application for processing to 847-956-9723
- We will notify you by phone, fax, or e-mail of credit approval

How to order from Stucchi USA Inc.

We prefer orders to be faxed or e-mailed using the Stucchi "Order Code" to eliminate any possible errors. Our technical staff is available to take your order, assist you in finding the correct part, or answer any questions.

Delivery / Shipment of orders

Every order received is treated as a rush order. You tell us how fast you need it! Standard orders accepted until 4:30pm for same day shipment. UPS Red orders are accepted until 5:15pm Central Time for same day shipment.

Price Quotes / Non-Catalog Items

Stucchi is constantly adding parts to its product offering. If a non-inventory or specialty part not listed in the catalog is needed please fill out the technical data page in the back of the catalog and fax or mail the information along with a sample if possible. Call us for price and availability on your hard to find items. Formal quotations for products are furnished upon request.

Company Policies

Credit Policy

Our credit terms are Net 30 days, less 1% 10 days. Accounts outstanding over 30 days are reviewed daily. All accounts that reach 30 days past due from invoice date will be changed to a COD account until past due amounts are paid. At 45 days past due all orders & backorders will automatically be put on credit hold until full payment is received. Payment for product in U.S. dollars.

Return Policy

Contact customer service to obtain a Returned Material Authorization (RMA) number. Our Receiving Department cannot accept a return without a proper number. Parts must be returned within 30 days of receipt of goods. Returned goods are subject to a 20% restocking fee. All returns are subject to inspection and may be rejected if not in resaleable condition.

Minimum Order and Invoice

All orders for less than \$100 are subject to a minimum net charge of \$100 plus shipping costs, unless waived by seller.

Delivery

Regardless of the billing method or the party selecting the carrier, risk of loss shall pass to Buyer upon Seller's delivery to a carrier. Delivery dates are approximate only and the seller shall have no liability for delays in delivery.

Limited Warranty

Stucchi manufactured products are warranted to the original user against defects in material and workmanship under normal use and proper installation (see Stucchi engineering CD for correct handling instructions) for one year after date of purchase, or 2000 operating hours, whichever comes first. The Seller's sole obligation under this warranty is limited to repairing or replacing, as hereinafter provided, at its option any product found to Seller's satisfaction to be defective upon examination by it within 30 days of discovery of defect. This warranty will not apply to any product that has been subject to abuse, accident, misapplication, or negligence. Warranty will not apply to altered products, repaired by someone other than seller and normal maintenance services and replacement of service items. Seller disclaims all warranties, expressed or implied, including but not limited to any implied warranties of merchantability or fitness for a particular purpose and any other obligation or liability. Stucchi strives to maintain the highest quality products to limit field service time due to failures in performance. If however, there is a need to return product, Stucchi's return policy requires a Returned Material Authorization (RMA) number.

Governing Laws

This agreement shall be construed to be between merchants. The laws of the State of Illinois shall govern any questions concerning its validity, construction of performance.



Product Index by Coupler Style and Interchange

Flat Face Style



Series "A" Premier
ISO 16028 Interchange
 Flat Face Coupling – In accordance with ISO 16028 for Interchange and Performance.
 Sizes: 1/8, 1/4, 3/8, 1/2, 5/8, 3/4, 1, 1 1/4, 1 1/2
 Threads: NPT, SAE, JIC, ORFS
Pages 6-9



Series "A" Premier International Threads
ISO 16028 Interchange
 Flat Face Coupling – In accordance with ISO 16028 for Interchange & Performance with International Port Configurations
 Sizes: 1/8, 1/4, 3/8, 1/2, 5/8, 3/4, 1, 1 1/4, 1 1/2
 Threads: BSP, DIN
Pages 10-13



Series FIRG
ISO 16028 Interchange
 Flat Face Couplings – In accordance with ISO 16028 for Interchange
 Sizes: 1/4, 3/8, 1/2, 5/8, 3/4, 1, 1 1/4, 1 1/2, 2
 Threads: NPT, SAE
Pages 14-16



Series APM
ISO 16028 Interchange
 Flat Face Nipple - Designed to connect in the presence of high internal residual pressure
 Sizes: 3/8, 1/2, 5/8, 3/4, 1, 1 1/4, 1 1/2
 Threads: NPT, SAE, JIC, ORFS, BSP, DIN
Pages 17-19



Series A-HD (formerly ASP)
ISO 16028 Interchange
 Flat Face Coupler - Designed to connect in the presence of high internal residual pressure
 Sizes: 1/2
 Threads: NPT, SAE, JIC
Pages 20-21



Series PP
ISO 16028 Interchange
 Flat Face Coupler - Designed with push/pull connection sleeve & clamp
 Sizes: 3/8, 1/2, 5/8, 3/4
 Threads: NPT, SAE
Page 22



Flat Face Style

Series FL Series FM
ISO 16028 Interchange
 Flat Face Coupling – 316 Stainless for corrosion.
 Size: 1/4, 3/8, 1/2, 5/8, 3/4, 1, 1 1/4, 1 1/2, 2
 Threads: NPT, SAE, BSP
Pages 23-25



Series FIRG Q
ISO 16028 Interchange
 Flat Face Coupling – QPQ Treatment & SS internal parts for corrosion.
 Size: 1/4, 3/8, 1/2, 5/8, 3/4, 1, 1 1/4, 1 1/2, 2
 Threads: NPT, SAE, BSP
Pages 26-28



Series "A" Premier Z
Flat Face Coupling - Special Zinc Treatment
 for corrosion applications.
 Size: 3/8, 1/2, 5/8, 3/4, 1.
 Threads: NPT
Page 29-30



Series A_HP
 Flat Face Coupling – 10,000 psi Working Pressure with Auto Lock sleeve.
 Size: 1/8, 1/4, 3/8
 Threads: NPT, BSP
Pages 31-32



Series VEP
 Flat Face Threaded Coupling - connectable/disconnect under high residual pressure.
 Size: 1/4, 3/8, 1/2, 3/4, 1, 1 1/4, 1 1/2, 2
 Threads: NPT, SAE, BSP, Flange Port
Pages 33-35



Series VEP HD
 Flat Face Threaded Coupling - connectable/disconnect under high residual pressure.
 Size: 1, 1 1/4, 1 1/2
 Threads: NPT, SAE
Pages 36-38



Series VP
 Flat Face Threaded Coupling - connectable /disconnect under high residual pressure. Locking sleeve
 Size: 1/4, 3/8, 1/2, 3/4, 1, 1 1/4, 1 1/2
 Threads: NPT, SAE, BSP
Pages 39-41



Poppet Style



Series BIR
ISO A Interchange
 Sizes: 1/4, 3/8, 1/2, 3/4, 1, 1 1/4, 1 1/2, 2
 Threads: NPT, BSP
Pages 42-44



Series IRB Series IRBO Series IRBX
ISO B Interchange
 Material: Steel, Brass, 316 Stainless
 Sizes: 1/4, 3/8, 1/2, 3/4, 1
 Threads: NPT, BSP
Pages 45-47



Series IR/V Series IRS/V Series IRS PC
Ag Style Interchange
 Poppet valve -Size: 1/4-1" -Thread: NPT.
 Standard & Push-Pull / 2 way sleeve. PC
 version for connecting with high internal
 static pressure
Pages 48-51



Series IR Series IRS
Ag Style Interchange
 Ball style valve – Thread: NPT
 Standard and Push-Pull / 2 way sleeve
Page 51

Miscellaneous Items



Series Wing
Wing Style Interchange
 Size: 3/4, 1, 1 1/4, 1 1/2
 Threads: NPT
Page 52



Series IVHP
Hydraulic Jack / Enerpac Interchange
 Thread to Connect 10,000 psi Working
 Pressure
 Sizes: 1/4, 3/8 Thread: NPT
Page 53



Series FIRG / ISO A Adaptor
Adaptor Coupler
 Size: 1/2
Page 54



Series IRH
Interchange: Tema "T" Series
Cejn 525 Series
 Size: 1/4, 3/8, 1/2, 3/4, 1
 Threads: NPT
Page 55-56

Miscellaneous Items

Series IV
Stucchi Only Threaded Poppet
Couplings
 Size: 1/4, 3/8, 1/2, 3/4, 1, 1 1/4, 1 1/2, 2
 Threads: BSP
Page 57



Series VU
Check Valves
 Cracking Point: 5 to 65 PSI
 Size: 1/4, 3/8, 1/2, 3/4, 1, 1 1/4, 1 1/2, 2
 Threads: NPT, SAE, BSP
Page 58-60



Multi-Coupling Plates, Dust Caps and Repair Kits

Series DP GR
 Single handle connection of multiple
 hydraulic couplings mounted in a plate.
 Size: 1/4 thru 1"
 Options: 2 to 10 coupling configurations
Page 61-66



Series GRE
 Single handle connection of multiple
 couplings for oil, water, pneumatics in
 industrial applications for quick tool
 changes.
 Size: 3/8, 1/2
 Options: 6, 12, 18 couplings per plate
Page 67-69



Series Specialty Couplers
Interchange: Stucchi Only
 Size: 1/2, 3/4, 2, 2 1/2, 3
 Threads: BSP, EXT, BSP-90
Page 70



Series SSB, SSR
Refrigeration Couplers
 Size: 3/8
 Threads: M14X1.5
Page 71



Series Dust Caps
Dust Caps
 PVC/Rubber blend for flat face, & poppet
 series Material: Aluminum of IVHP, VP, VEP
 series Material Brass for Wing Style
Page 72-74



Series Repair Kits
Repair Kits
 Repair kits for ISO A, Flat-Face, VEP Series
Page 75

Flat Face



Overview:

"A" Series or Premier Series offers higher pressure ratings, superior flow ratings, lower pressure drop compared to FIRG Series or competitors products.

Applications:

Flat Face couplers are specifically designed for applications needing no-leak performance. The mating faces are easily cleaned before connecting, making it the ideal solution for limiting contamination in a hydraulic circuit. The design allows applications involving high pressure impulses in agriculture equipment, mobile construction equipment and general industrial plants. Non-Spill design avoids fluid loss in connection & disconnection.

Options:

- Seals: Viton, EPDM, & Kalrez.
- Threads: NPT, SAE, ORFS, JIC
- Multiple mounting options

Series: "A" Premier

Interchange: ISO 16028 Flat Face

"A" series couplings are in accordance for Interchangeability and performances of ISO 16028. The interchangeability of size 10 is also in accordance with NFPA T3.20.15 (HTMA).

Interchange: Parker FEM, Aeroquip FD89, Faster 2FFI, Snap-Tite 74

- Seals: Nitrile & Teflon anti-extrusion
- Nipple: Hardened steel reduces brinnelling
- 12 to 20 balls to increase the male bearing points & decrease the brinelling effect
- Modular structure for multiple port option
- Lock system stops unwanted disconnect
- Exceeds Impulse test of ISOA-7241 test

Stucchi Series	Nominal Size Inches	ISO Size MM	MAX OPERATING PRESSURE COUPLED bar	MAX OPERATING PRESSURE COUPLED PSI
A4	1/8	5.0	420	6000
A7	1/4	6.3	420	6000
A9	3/8	10.0	350	5000
A13	1/2	12.5	330	4714
A15	5/8	16.0	330	4714
A17	3/4	19.0	330	4714
A21	1	25.0	300	4286
A25	1 ¼	27.0	300	4286
A30	1 ½	31.5	270	3857

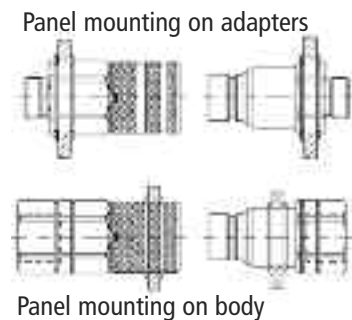
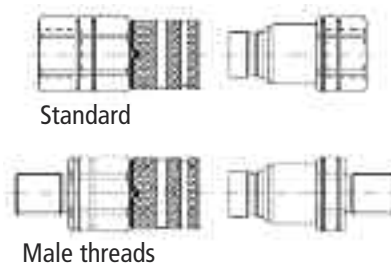

Item	Body Size	Size (MM)	A inch	B (mm)	C (mm)	D (mm)	E (mm)	F (mm)	G (mm)	I (mm)
A4	1/8"	5	1/8"	36.5	20	40	68.5	18.5	20.5	11
A7	1/4"	6.3	1/4"	48	28	53	90.5	24	29	16.2
A9	3/8"	10	3/8"	60	32	64.5	109	29	32	19.8
A9	3/8"	10	1/2"	62.5	32	69.5	116.5	29	32	19.8
A13	1/2"	12.5	1/2"	68	38	76.5	127.5	40	40	24.5
A13	1/2"	12.5	3/4"	70.5	38	83.5	137	40	40	24.5
A15	5/8"	16	3/4"	73	42	83.5	139.5	38.5	45	27
A17	3/4"	19	1"	84	48	98.5	161	50	50	30
A21	1"	21	1 1/4"	90	55	105	173	60	60	36
A25	1 1/4"	25	1 1/4"	105	65	125.1	206.9	59.8	65	44.1
A30	1 1/2"	31.5	1 1/2"	111	80	132.5	215	70	82	57

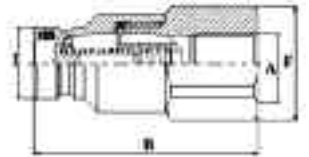
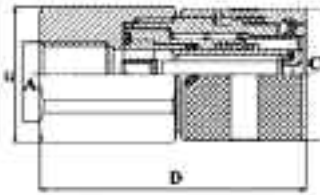
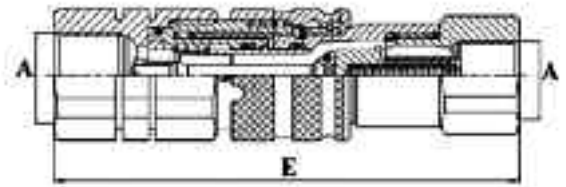
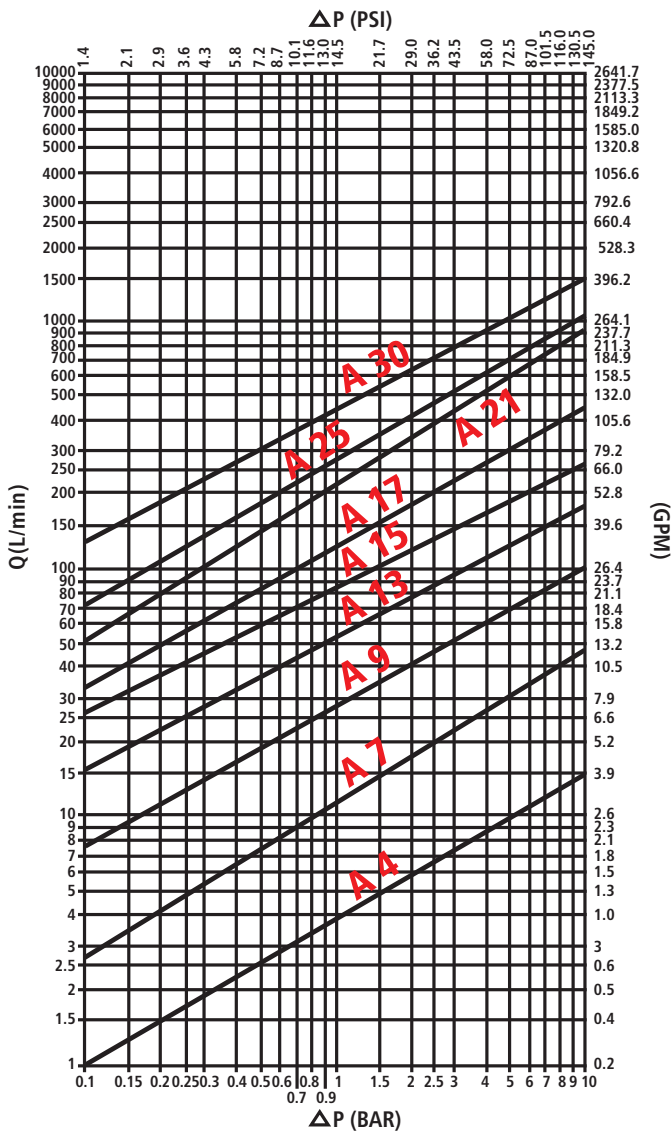

Panel mount options available upon request.

ISO 16028 Interchange Couplings Flat Face



Coupler



Nipple



Stucchi

Interchange: Parker FEM Series, Aeroquip FD89
ISO 16028 Interchange: NPT Thread

Part	Body Size	Port Size	Thread Type	Order Code	Part Description
Coupler	1/8	1/8	NPT	801301002	F. A4 1/8 NPT
Nipple	1/8	1/8	NPT	801301003	M. A4 1/8 NPT
Coupler	1/4	1/4	NPT	801301004	F. A7 1/4 NPT
Nipple	1/4	1/4	NPT	800801001	M. FIRG 14 NPT
Coupler	3/8	3/8	NPT	801301006	F. A9 3/8 NPT
Nipple	3/8	3/8	NPT	801301005	M. A9 3/8 NPT
Coupler	3/8	1/2	NPT	801301008	F. A9 1/2 NPT
Nipple	3/8	1/2	NPT	801301007	M. A9 1/2 NPT
Coupler	1/2	1/2	NPT	801301010	F. A13 1/2 NPT
Nipple	1/2	1/2	NPT	801301009	M. A13 1/2 NPT
Coupler	1/2	3/4	NPT	801301012	F. A13 3/4 NPT
Nipple	1/2	3/4	NPT	801301011	M. A13 3/4 NPT
Coupler	5/8	3/4	NPT	801301014	F. A15 3/4 NPT
Nipple	5/8	3/4	NPT	801301013	M. A15 3/4 NPT
Coupler	5/8	1	NPT	801301020	F. A15 1" NPT
Nipple	5/8	1	NPT	801301019	M. A15 1" NPT
Coupler	3/4	3/4	NPT	801301030	F. A17 3/4 NPT
Nipple	3/4	3/4	NPT	801301031	M. A17 3/4 NPT
Coupler	3/4	1	NPT	801301000	F. A17 1" NPT
Nipple	3/4	1	NPT	801301001	M. A17 1" NPT
Coupler	1	1	NPT	801301028	F. A21 1" NPT
Nipple	1	1	NPT	801301029	M. A21 1" NPT
Coupler	1	1 1/4	NPT	801301016	F. A21 11/4 NPT
Nipple	1	1 1/4	NPT	801301015	M. A21 11/4 NPT
Coupler	1 1/4	1 1/4	NPT	801301034	F. A25 11/4 NPT
Nipple	1 1/4	1 1/4	NPT	801301035	M. A25 11/4 NPT
Coupler	1 1/2	1 1/2	NPT	801301018	F. A30 11/2 NPT
Nipple	1 1/2	1 1/2	NPT	801301017	M. A30 11/2 NPT

Skid Steer Applications: Custom Ports
Interchange: Parker FEM Series, Aeroquip FD89
ISO 16028 Interchange: -Male Threads

Part	Body Size	Port Size	Thread Type	Order Code	Part Description
Coupler	3/8	1/2	JIC Bulkhead	801306014	F. A9 1/2 JIC BH
Nipple	3/8	1/2	JIC Bulkhead	801306015	M. A9 1/2 JIC BH
Coupler	1/2	5/8	JIC Bulkhead	803306000	F. A13D 5/8 JIC BH
Nipple	1/2	5/8	JIC Bulkhead	801306017	M. A13 5/8 JIC BH
Coupler	1/2	3/4	JIC Bulkhead	801306024	F. A13 3/4 JIC BH
Nipple	1/2	3/4	JIC Bulkhead	801306025	M. A13 3/4 JIC BH
Coupler	3/4	3/4	JIC Bulkhead	801306028	F. A17 3/4 JIC BH
Nipple	3/4	3/4	JIC Bulkhead	801306029	M. A17 3/4 JIC BH
Coupler	1/2	5/8	JIC INT	803706002	F. A13 TI 5/8 JIC INT
Nipple	1/2	5/8	JIC INT	803706003	M. A13 TI 5/8 JIC INT
Coupler	1/2	5/8	ORFS Bulkhead	803313000	F. A13D 5/8 ORFSBH
Nipple	1/2	5/8	ORFS Bulkhead	801313001	M. A13 5/8 ORFSBH
Coupler	1/2	3/4	ORFS Bulkhead	803313002	F. A13D 3/4 ORFSBH
Nipple	1/2	3/4	ORFS Bulkhead	801313005	M. A13 3/4 ORFSBH
Coupler	1/2	1	ORFS Bulkhead	803313004	F. A13D 1" ORFSBH
Nipple	1/2	1	ORFS Bulkhead	801313007	M. A13 1" ORFSBH

Interchange: Parker FEM Series, Aeroquip FD89
ISO 16028 Interchange: -SAE Thread

Part	Body Size	Port Size	Thread Type	Order Code	Part Description
Coupler	1/8	1/8	SAE	801304002	F. A4 3/16 SAE
Nipple	1/8	1/8	SAE	801304003	M. A4 3/16 SAE
Coupler	1/4	3/8	SAE	801304004	F. A7 3/8 SAE
Nipple	1/4	3/8	SAE	800804001	M. FIRG 14 3/8 SAE
Coupler	3/8	3/8	SAE	801304006	F. A9 3/8 SAE
Nipple	3/8	3/8	SAE	801304005	M. A9 3/8 SAE
Coupler	3/8	1/2	SAE	801304008	F. A9 1/2 SAE
Nipple	3/8	1/2	SAE	801304007	M. A9 1/2 SAE
Coupler	3/8	5/8	SAE	801304030	F. A9 5/8 SAE
Nipple	3/8	5/8	SAE	801304031	M.A9 5/8 SAE
Coupler	1/2	1/2	SAE	803304004	F. A13 1/2 SAE
Nipple	1/2	1/2	SAE	801304035	M. A13 1/2 SAE
Coupler	1/2	5/8	SAE	801304024	F. A13 5/8 SAE
Nipple	1/2	5/8	SAE	801304025	M. A13 5/8 SAE
Coupler	1/2	3/4	SAE	801304010	F. A13 3/4 SAE
Nipple	1/2	3/4	SAE	801304009	M. A13 3/4 SAE
Coupler	5/8	3/4	SAE	801304012	F. A15 3/4 SAE
Nipple	5/8	3/4	SAE	801304011	M. A15 3/4 SAE
Coupler	3/4	3/4	SAE	801304028	F. A17 3/4 SAE
Nipple	3/4	3/4	SAE	801304029	M. A17 3/4 SAE
Coupler	3/4	1	SAE	801304000	F. A17 1" SAE
Nipple	3/4	1	SAE	801304001	M. A17 1" SAE
Coupler	1	1	SAE	801304038	F. A21 1" SAE
Nipple	1	1	SAE	801304039	M. A21 1" SAE
Coupler	1	1 1/4	SAE	801304014	F. A21 11/4 SAE
Nipple	1	1 1/4	SAE	801304013	M. A21 11/4 SAE
Coupler	1 1/4	1 1/4	SAE	801304042	F. A25 11/4 SAE
Nipple	1 1/4	1 1/4	SAE	801304043	M. A25 11/4 SAE
Coupler	1 1/2	1 1/2	SAE	801304016	F. A30 11/2 SAE
Nipple	1 1/2	1 1/2	SAE	801304015	M. A30 11/2 SAE



Coupler



Nipple

Hand Tool Applications: Special Configuration
Interchange: Parker FEM Series, Aeroquip FD49 Interchange: ISO 16028

Part	Body Size	Port Size	Thread Type	Order Code	Part Description
Coupler	3/8	3/8	Male SAE	803704004	F. A9 3/8 T30 SAE EXT.
Nipple	3/8	3/8	Male SAE	801304037	M.A9 3/8 SAE EXT
Coupler	3/8	1/2	Male SAE	803704006	F. A9 1/2 T30 SAE EXT.
Coupler	3/8	1/2	Male SAE	801304032	F.A9 1/2 SAE EXT
Nipple	3/8	1/2	Male SAE	801304033	M.A9 1/2 SAE EXT
Coupler	3/8	3/8	Female NPT	803601000	F. FIRG 38 T30 NPT
Coupler	3/8	1/2	Female NPT	803601002	F. FIRG 12 T30 NPT



ISO 16028 Interchange Couplings Flat Face: International Ports



All features & benefits of "A" Premier Series with convenient International Port configurations

- Seals: Nitrile & Teflon anti-extrusion
- Eliminate hard to find adapters and leak points
- Nipple: Hardened steel reduces brinnelling
- 12 to 20 balls to increase the male bearing points & decrease the brinelling effect
- Lock system stops unwanted disconnect
- Exceeds Impulse test of ISOA-7241 test

Series: "A"
Premier
Interchange: ISO 16028
Flat Face
"A" series couplings are in compliance for interchangeability & performance of ISO 16028 International Ports: **British** or **German DIN**

ISO 16028 Interchange: International Ports BSP

Part	Body Size	Thread Type	Thread Size	Port Thread	Order Code	Part Description
Coupler	1/8	BSP	1/8	1/8 - 19	801300002	F. A4 1/8 BSP
Nipple	1/8	BSP	1/8	1/8 - 19	801300003	M. A4 1/8 BSP
Coupler	1/4	BSP	1/4	1/4 - 19	801300004	F. A7 1/4 BSP
Nipple	1/4	BSP	1/4	1/4 - 19	801300031	M. A7 1/4 BSP
Nipple	3/8	BSP	3/8	3/8 - 19	801300005	M.A9 3/8" BSP
Coupler	3/8	BSP	3/8	3/8 - 19	801300006	F. A9 3/8 BSP
Nipple	3/8	BSP	1/2	1/2 - 14	801300007	M.A9 1/2" BSP
Coupler	3/8	BSP	1/2	1/2 - 14	801300008	F. A9 1/2" BSP
Nipple	1/2	BSP	1/2	1/2 - 14	801300013	M.A13 1/2" BSP
Coupler	1/2	BSP	1/2	1/2 - 14	801300014	F.A13 1/2" BSP
Nipple	1/2	BSP	3/4	3/4 - 14	801300015	M. A13 3/4" BSP
Coupler	1/2	BSP	3/4	3/4 - 14	801300016	F.A13 3/4" BSP
Nipple	5/8	BSP	3/4	3/4 - 14	801300021	M.A15 3/4" BSP
Coupler	5/8	BSP	3/4	3/4 - 14	801300022	F.A15 3/4" BSP
Coupler	3/4	BSP	1	1 - 11	801300000	F.A17 1" BSP
Nipple	3/4	BSP	1	1 -11	801300001	M.A17 1" BSP
Nipple	1	BSP	1 ¼	1 ¼ - 11	801300023	M.A21 1 ¼" BSP
Coupler	1	BSP	1 ¼	1 ¼ - 11	801300024	F.A21 1 ¼" BSP
Coupler	1 ½	BSP	1 ½	1 ½-11	801300026	F. A30 1 ½ BSP
Nipple	1 ½	BSP	1 ½	1 ½-11	801300025	M. A30 1 ½ BSP
Coupler	1 ½	BSP	2	2	801300038	F. A30 2" BSP
Nipple	1 ½	BSP	2	2	801300039	M. A30 2" BSP



Call us at 847-956-9720, Fax at 847-956-9723, or visit us on the web www.stucchiusa.com

ISO 16028 Interchange: International Ports- DIN 3852: L (Light) and S (Heavy)

Part	Body Size	Metric Thread	Port Series	Tube O.D.	Thread Size	Order Code	Part Description
Coupler	1/4	DIN	L	10	M 16X1.5	801308010	F. A7 L10
Nipple	1/4	DIN	L	10	M 16X1.5	801308011	M. A7 L10
Coupler	3/8	DIN	L	10	M 16X1.5	801308008	F. A9 L10
Nipple	3/8	DIN	L	10	M 16X1.5	801308009	M. A9 L10
Coupler	3/8	DIN	L	12	M 18X1.5	801308004	F. A9 L12
Nipple	3/8	DIN	L	12	M 18X1.5	801308005	M.A9 L12
Coupler	3/8	DIN	L	15	M 22X1.5	801308006	F. A9 L15
Nipple	3/8	DIN	L	15	M 22X1.5	801308007	M. A9 L15
Coupler	1/2	DIN	L	12	M 18X1.5	801308000	F. A13 L12
Nipple	1/2	DIN	L	12	M 18X1.5	801308001	M. A13 L12
Coupler	1/2	DIN	L	15	M 22X1.5	801308002	F. A13 L15
Nipple	1/2	DIN	L	15	M 22X1.5	801308003	M. A13 L15
Coupler	5/8	DIN	L	15	M 22X1.5	801308016	F. A15 L15
Nipple	5/8	DIN	L	15	M 22X1.5	801308017	M. A15 L15
Coupler	5/8	DIN	L	22	M 30X2	801308020	F. A15 L22
Nipple	5/8	DIN	L	22	M 30X2	801308021	M. A15 L22
Coupler	3/4	DIN	L	22	M 30X2	801308024	F. A17 L22
Nipple	3/4	DIN	L	22	M 30X2	801308025	M. A17 L22
Coupler	1/4	DIN	S	10	M 18X1.5	801309004	F. A7 S10
Nipple	1/4	DIN	S	10	M 18X1.5	801309005	M. A7 S10
Coupler	3/8	DIN	S	10	M 18X1.5	801309006	F. A9 S10
Nipple	3/8	DIN	S	10	M 18X1.5	801309007	M. A9 S10
Coupler	3/8	DIN	S	12	M 20X1.5	801309008	F. A9 S12
Nipple	3/8	DIN	S	12	M 20X1.5	801309009	M. A9 S12
Coupler	1/2	DIN	S	12	M 20X1.5	801309014	F. A13 S12
Nipple	1/2	DIN	S	12	M 20X1.5	801309015	M. A13 S12
Coupler	3/8	DIN	Female	22	M 22X1.5	801312000	F.A9 M22X1.5
Nipple	3/8	DIN	Female	22	M 22X1.5	801312001	M. A9 M22X1.5



Coupler - L (Light) or S (Heavy)



Nipple -Ports Series: L (Light) or S (Heavy)

ISO 16028 Interchange Couplings Flat Face: International Ports

ISO 16028 Interchange: International Ports- DIN 3852: L (Light) and S (Heavy)- SCHOTT (Bulkhead)

Part	Body Size	Metric Thread	Port Series	Tube O.D.	Thread Size	Order Code	Part Description
Coupler	1/4	DIN	L	10	M 16X1.5 SCHOTT	801310010	F. A7 L10 SCHOTT
Nipple	1/4	DIN	L	10	M 16X1.5 SCHOTT	801310011	M. A7 L10 SCHOTT
Coupler	3/8	DIN	L	12	M 18X1.5 SCHOTT	801310004	F. A9 L12 SCHOTT
Nipple	3/8	DIN	L	12	M 18x1.5SCHOTT	801310005	M.A9 L12 SCHOTT
Coupler	3/8	DIN	L	15	M 16X1.5 SCHOTT	801310006	F. A9 L15 SCHOTT
Nipple	3/8	DIN	L	15	M 16X1.5 SCHOTT	801310007	M. A9 L15 SCHOTT
Coupler	3/8	DIN	L	10	M 16X1.5 SCHOTT	801310008	F. A9 L10 SCHOTT
Nipple	3/8	DIN	L	10	M 16X1.5 SCHOTT	801310009	M. A9 L10 SCHOTT
Coupler	1/2	DIN	L	12	M 18X1.5 SCHOTT	801310000	F. A13 L12 SCHOTT
Nipple	1/2	DIN	L	12	M 18X1.5 SCHOTT	801310001	M. A13 L12 SCHOTT
Coupler	1/2	DIN	L	15	M 22X1.5 SCHOTT	801310002	F. A13 L15 SCHOTT
Nipple	1/2	DIN	L	15	M 22X1.5 SCHOTT	801310003	M. A13 L15 SCHOTT
Coupler	5/8	DIN	L	18	M 26X1.5 SCHOTT	801310018	F. A15 L18 SCHOTT
Nipple	5/8	DIN	L	18	M 26X1.5 SCHOTT	801310019	M. A15 L18 SCHOTT
Coupler	5/8	DIN	L	22	M 30X1.5 SCHOTT	801310020	F. A15 L22 SCHOTT
Nipple	5/8	DIN	L	22	M 30X1.5 SCHOTT	801310021	M. A15 L22 SCHOTT
Coupler	3/4	DIN	L	18	M 26X1.5 SCHOTT	801310022	F. A17 L18 SCHOTT
Nipple	3/4	DIN	L	18	M 26X1.5 SCHOTT	801310023	M. A17 L18 SCHOTT
Coupler	3/4	DIN	L	22	M 30X1.5 SCHOTT	801310024	F. A17 L22 SCHOTT
Nipple	3/4	DIN	L	22	M 30X1.5 SCHOTT	801310025	M. A17 L22 SCHOTT
Coupler	3/8	DIN	S	12	M 20X1.5 SCHOTT	801311008	F. A9 S12 SCHOTT
Nipple	3/8	DIN	S	12	M 20X1.5 SCHOTT	801311009	M. A9 S12 SCHOTT
Coupler	1/2	DIN	S	12	M 20X1.5 SCHOTT	801311014	F. A13 S12 SCHOTT
Nipple	1/2	DIN	S	12	M 20X1.5 SCHOTT	801311015	M. A13 S12 SCHOTT
Coupler	1/2	DIN	S	16	M 24X1.5 SCHOTT	801311018	F.A13 S16 SCHOTT
Nipple	1/2	DIN	S	16	M 24X1.5 SCHOTT	801311019	M.A13 S16 SCHOTT
Coupler	3/4	DIN	S	16	M 24X1.5 SCHOTT	801311022	F. A15 S16 SCHOTT
Nipple	3/4	DIN	S	16	M 24X1.5 SCHOTT	801311023	M. A15 S16 SCHOTT
Coupler	3/4	DIN	S	20	M 30X1.5 SCHOTT	801311024	F. A15 S20 SCHOTT
Nipple	3/4	DIN	S	20	M 30X1.5 SCHOTT	801311025	M. A15 S20 SCHOTT

*SCHOTT = DIN Bulkhead



Coupler: - L (Light) and S (Heavy) SCHOTT



Nipple: - L (Light) and S (Heavy) SCHOTT



Call us at 847-956-9720, Fax at 847-956-9723, or visit us on the web www.stucchiusa.com

International Ports –Din 3852 L (Light) & S (Heavy): Couplers - No Safety Lock Mechanism

Part	Body Size	Metric Thread	Metric Series	Tube O.D.	Thread Size	Stucchi Code	Part Description
Coupler	1/4	DIN	L	10	M 16X1.5 SCHOTT	803010008	F.A7 SS L10 SCHOTT
Coupler	3/8	DIN	L	10	M 16X1.5 SCHOTT	803010010	F.A9 SS L10 SCHOTT
Coupler	3/8	DIN	L	12	M 18X1.5 SCHOTT	803010004	F.A9 SS L12 SCHOTT
Coupler	3/8	DIN	L	15	M 22X1.5 SCHOTT	803010006	F.A9 SS L15 SCHOTT
Coupler	1/2	DIN	L	12	M 18X1.5 SCHOTT	803010000	F.A13 SS L12 SCHOTT
Coupler	1/2	DIN	L	15	M 22X1.5 SCHOTT	803010002	F.A13 SS L15 SCHOTT
Coupler	1/2	DIN	L	22	M 22X2 SCHOTT	803010012	F.A13 SS L22 SCHOTT
Coupler	3/8	DIN	L	15	M 22X1.5	803108000	F. A9 K SS L15
Coupler	3/8	DIN	L	12	M 18X1.5	803108002	F. A9 K SS L12
Coupler	3/8	DIN	L	12	M 18X1.5	803008004	F.A9 SS L12
Coupler	3/8	DIN	L	15	M 22X1.5	803008006	F. A9 SS L15
Coupler	3/8	DIN	L	10	M 16X1.5	803008010	F. A9 SS L10
Coupler	1/2	DIN	L	22	M 22X2	803008018	F. A13 SS L22
Coupler	3/4	DIN	L	22	M 22X2	803008016	F. A15 SS L22
Coupler	3/8	DIN	S	12	M 20X1.5	803009000	F. A9 SS S12
Coupler	1/2	DIN	S	12	M 20X1.5	803009002	F. A13 SS S12
Coupler	1/2	DIN	S	16	M 24X1.5 SCHOTT	803011000	F. A13 SS S16 SCHOTT
Coupler	1/2	DIN	S	20	M 30X2 SCHOTT	803011002	F. A13 SS S20 SCHOTT

*SCHOTT = DIN Bulkhead

To identify the DIN fitting size measure the following:

Using a thread gauge, determine the number of millimeters per thread.

With calipers, find the thread diameter by measuring the O.D. on the male and I.D. on the female.

Measure the Tube O.D. with the calipers so you can identify the fitting as either Light Series or Heavy Series.

ISO 16028 Interchange Couplings Flat Face



Series: FIRG Interchange: ISO 16028

The "FIRG" quick coupling, head of the family of flat face, produced since 1983. **Interchangeability** in accordance with ISO 16028. The interchangeability of size 10 is also in accordance with NFPA T3.20.15 (HTMA).

Interchange: Faster 2FFI, Aeroquip FD89 / FD49, Parker FE, FF size 3/8

- Nitrile seal with specially shaped anti extrusion rings in Teflon.
- "FIRG" designed integrated sealing mechanism greatly reduces premature wear by movement between coupler & nipple parts caused by impulse pressure and by the weight of the flexible pipes when the coupling is in horizontal position.

Overview: The "Original One", that is the FIRG flat-face series from Stucchi. Developed in 1982, Stucchi has supplied the original ISO 16028 interchangeable coupling, and still continues to supply this series due to the good performance, long life and competitive prices on this series.

Applications: Mobile Construction, Agriculture, General Industrial, Mining or anywhere fluid loss and contamination of a hydraulic circuit needs to be eliminated.

Product Features & Options:

- Couplings: Zinc plated steel
- Nipple: hardened steel for anti-brinelling
- Seals: Nitrile with Teflon anti-extrusion ring. Viton, Kalzrez, EPDM upon request
- Ports: NPT, SAE
- Tight Tolerances ensure equal loading of couplers
- Female Seal swaged to prevent extrusion
- No air inclusion during connection
- Flat mating surface easily cleaned
- Non-spill design avoids fluid loss during connection / disconnection

Stucchi Series	Nominal Size Inches	ISO Size MM	MAX OPERATING PRESSURE COUPLED bar	MAX OPERATING PRESSURE COUPLED PSI
FIRG 14	1/4	6.3	300	4285
FIRG 38/12	3/8	10.0	300	4285
FIRG 12A/34	1/2	12.5	250	3571
FIRG 34B	5/8	16.0	250	3571
FIRG 34A	3/4	19.0	250	3571
FIRG 100	3/4	19.0	250	3571
FIRG 114	1	25.0	250	3571
FIRG 112	1 1/2	31.5	200	2857
FIRG 200	2	40.0	200	2857



Call us at 847-956-9720, Fax at 847-956-9723, or visit us on the web www.stucchiusa.com

Item	Body Size	Size (MM)	A inch	B (mm)	C (mm)	D (mm)	E (mm)	F (mm)	G (mm)	I (mm)
FIRG 14	1/4"	6.3	1/4"	47.9	28	48.1	85.2	23.8	23.8	16.2
FIRG 38	3/8"	10	3/8"	60	32	64.2	108.7	26	29	19.8
FIRG 12	3/8"	10	3/8"	62.5	32	69.2	116.2	29	29	19.8
FIRG 12A	1/2"	12.5	1/2"	68	38	73.8	124.6	33.8	33.8	24.5
FIRG 34	1/2"	12.5	3/4"	70.5	38	80.8	134.1	38.5	38.5	24.5
FIRG 34B	5/8"	16	3/4"	70.5	42	78.5	131.5	38.5	38.5	27
FIRG 34A	3/4"	19	3/4"	82.5	48	93.2	153.9	47.8	47.8	30
FIRG 100	3/4"	19	1"	82.5	48	93.2	153.9	47.8	47.8	30
FIRG 114	1	25	1 1/2"	90	55	106	173	59.8	59.8	36
FIRG 112	1 1/2"	31.5	1 1/2"	111	80	132.4	215	72	76	57
FIRG 200	2"	40	2"	125	100	156.6	242.8	83.5	88.5	73

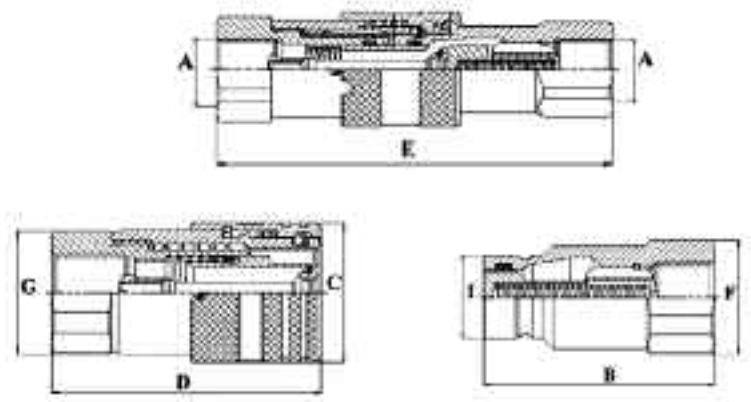
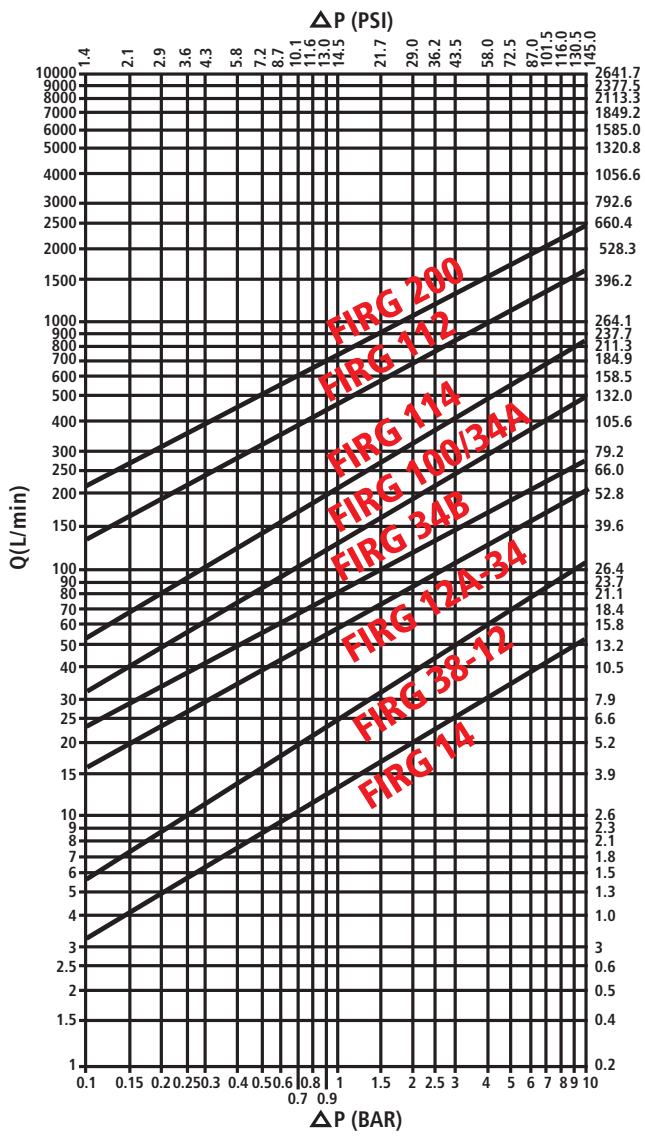

Panel mount options available upon request.

ISO 16028 Interchange Couplings Flat Face

Interchange: Parker FE Series, Aeroquip FD89
ISO 16028 Interchange: -NPT Thread



Coupler



Nipple

Part	Body Size	Port Size	Thread Type	Order Code	Part Description
Coupler	1/4	1/4	NPT	800801000	F. FIRG 14 NPT
Nipple	1/4	1/4	NPT	800801001	M. FIRG 14 NPT
Coupler	3/8	1/2	NPT	800801002	F. FIRG 12 NPT
Nipple	3/8	1/2	NPT	800801003	M. FIRG 12 NPT
Coupler	3/8	3/8	NPT	800801004	F. FIRG 38 NPT
Nipple	3/8	3/8	NPT	800801005	M. FIRG 38 NPT
Coupler	1/2	1/2	NPT	800801006	F. FIRG 12A NPT
Nipple	1/2	1/2	NPT	800801007	M. FIRG 12ANPT
Coupler	1/2	3/4	NPT	800801008	F. FIRG 34 NPT
Nipple	1/2	3/4	NPT	800801009	M. FIRG 34 NPT
Coupler	5/8	3/4	NPT	800801010	F. FIRG 34B NPT
Nipple	5/8	3/4	NPT	800801011	M. FIRG 34B NPT
Coupler	3/4	3/4	NPT	800801020	F. FIRG 34A NPT
Nipple	3/4	3/4	NPT	800801021	M. FIRG 34A NPT
Coupler	3/4	1	NPT	800801012	F. FIRG 100 NPT
Nipple	3/4	1	NPT	800801013	M. FIRG 100 NPT
Coupler	1	1 1/4	NPT	800801014	F. FIRG 114 NPT
Nipple	1	1 1/4	NPT	800801015	M. FIRG 114 NPT
Coupler	1 1/2	1 1/2	NPT	800801016	F. FIRG 112 NPT
Nipple	1 1/2	1 1/2	NPT	800801017	M. FIRG 112 NPT
Coupler	2	2	NPT	800801018	F. FIRG 200 NPT
Nipple	2	2	NPT	800801019	M. FIRG 200 NPT

Interchange: Parker FE Series, Aeroquip FD89
ISO 16028 Interchange: -SAE Thread



Coupler



Nipple

Part	Body Size	Port Size	Thread Type	Order Code	Part Description
Coupler	1/4	3/8	SAE	800804000	F. FIRG 14 3/8 SAE
Nipple	1/4	3/8	SAE	800804001	M.FIRG 14 3/8 SAE
Coupler	3/8	1/2	SAE	800804002	F. FIRG 38 1/2 SAE
Nipple	3/8	1/2	SAE	800804003	M.FIRG 38 1/2 SAE
Coupler	3/8	5/8	SAE	800804004	F. FIRG 12 5/8 SAE
Nipple	3/8	5/8	SAE	800804005	M.FIRG 12 5/8 SAE
Coupler	1/2	5/8	SAE	800804006	F. FIRG 12A 5/8 SAE
Nipple	1/2	5/8	SAE	800804007	M.FIRG 12A 5/8 SAE
Coupler	1/2	3/4	SAE	800804008	F. FIRG 34 SAE
Nipple	1/2	3/4	SAE	800804009	M.FIRG 34 SAE
Coupler	5/8	3/4	SAE	800804010	F. FIRG 34B SAE
Nipple	5/8	3/4	SAE	800804011	M.FIRG 34B SAE
Coupler	3/4	3/4	SAE	800804020	F. FIRG 34A SAE
Nipple	3/4	3/4	SAE	800804021	M.FIRG 34A SAE
Coupler	3/4	1	SAE	800804012	F. FIRG 100 SAE
Nipple	3/4	1	SAE	800804013	M.FIRG 100 SAE
Coupler	1	1 1/4	SAE	800804014	F. FIRG 114 SAE
Nipple	1	1 1/4	SAE	800804015	M.FIRG 114 SAE
Coupler	1 1/2	1 1/2	SAE	800804016	F. FIRG 112 SAE
Nipple	1 1/2	1 1/2	SAE	800804017	M.FIRG 112 SAE
Coupler	2	2	SAE	800804018	F. FIRG 200 SAE
Nipple	2	2	SAE	800804019	M.FIRG 200 SAE



Stucchi

ISO 16028 Interchange Couplings Connect Under Pressure



Series: APM

Interchange: ISO 16028

Male coupling "APM" series is the Stucchi solution to the problem of the connection in the presence of high internal residual pressure. Patented double internal security valve system in the male part allows the "APM" series to solve the problem of manual connections in the presence of high residual pressure. The "APM" series nipples are in accordance with ISO 16028 for interchangeability & performance.

- Zinc plated hardened steel
- Seals: Nitrile / Teflon Standard
- NPT-SAE Standard Ports, Others per request
- Connect with ISO 16028 Coupler
- Connect up to 250 bar residual pressure

Overview: Stucchi APM Series Male Couplings will connect by hand with residual pressure of 250 bar or 3571 psi locked in the hydraulic circuit. It will connect with residual pressure without releasing any fluid into the environment. The mating circuit will need to be without residual pressure.

Applications: Mobile equipment & attachment tools where exposure to the sun, or temperature change causes pressure to develop due to thermal expansion of trapped fluid. Any application where static pressure can get locked into the system.

Advantages:

- Connects under high pressure by hand.
- No air inclusion during connection
- Bi-Directional Flow
- Elimination of fluid loss during connection or disconnection.
- Easily cleaned before connection
- Interchangeable with ISO 16028

Operation: To Connect wipe the mating surfaces clean, align the coupling & nipple, push together. To Disconnect, pull back the sleeve on the female and the couplers release.

Stucchi Series	Nominal Size Inches	ISO Size MM	MAX OPERATING PRESSURE COUPLED bar	MAX OPERATING PRESSURE COUPLED PSI
APM9	3/8	10.0	350	5000
APM13	1/2	12.5	330	4714
APM15	5/8	16.0	330	4714
APM17	3/4	19.0	330	4714
APM21	1	25.0	300	4286
APM30	1 1/2	31.5	270	3857

ISO 16028 Interchange Couplings Connect Under Pressure

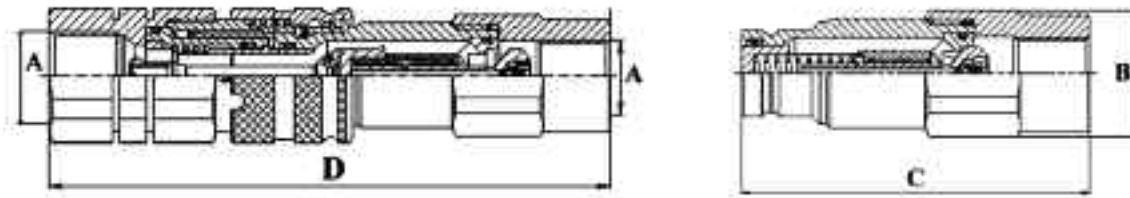

APM Series Male Connected to "A" Series Female Coupler

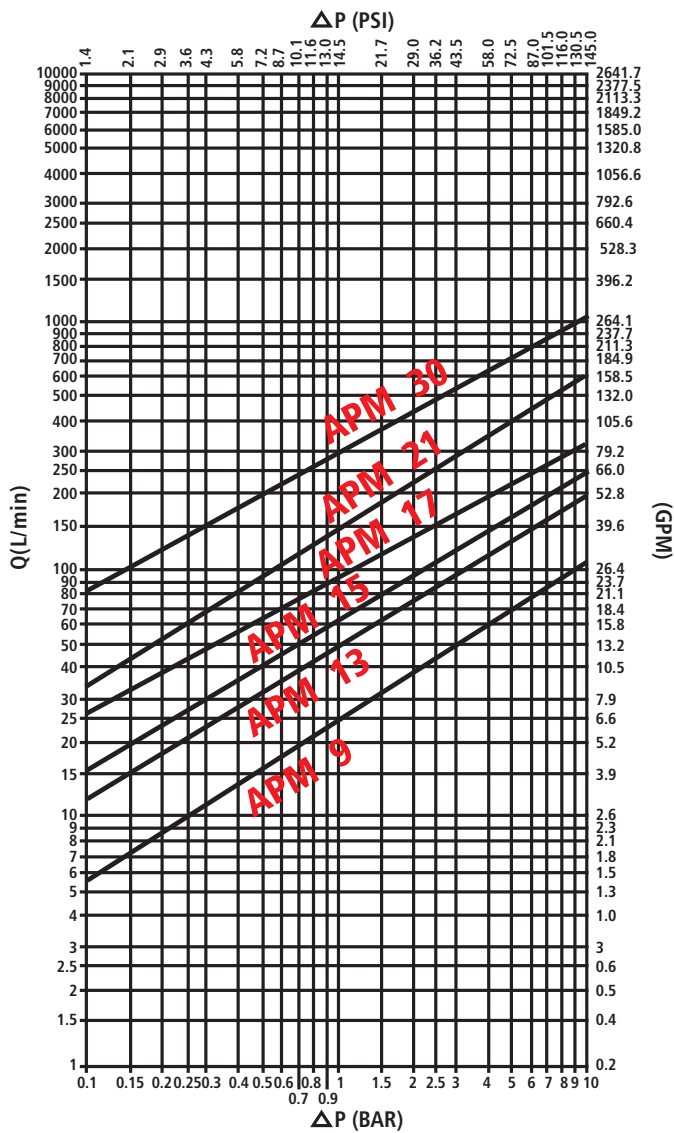

Item	Body Size	Size (MM)	A inch	B (mm)	C (mm)	D (mm)
APM 9	3/8	10	3/8	29	80	135
APM 9	3/8	10	1/2	29	82.5	138
APM 13	1/2	12.5	1/2	38.5	91	157
APM 13*	1/2	12.5	3/4	38.5	93.5	161
APM 13	1/2	12.5	3/4	38.5	91	157
APM 15	5/8	16	3/4	38.5	95	161
APM 17	3/4	19.0	1	49.8	109	157
APM 21	1	25.0	1 1/4	59.8	123.5	162
APM 30	1 1/2	31.5	1 1/2	75.8	146.9	186

*SAE THREAD



Call us at 847-956-9720, Fax at 847-956-9723, or visit us on the web www.stucchiusa.com

ISO 16028 Interchange: Nipple Connect Under Pressure Series: APM-8052

Part	Body Size	Port Size	Thread Type	Order Code	Part Description
Nipple	3/8	3/8	NPT	805201001	M. APM 9 3/8 NPT
Nipple	3/8	1/2	NPT	805201003	M. APM 9 1/2 NPT
Nipple	1/2	1/2	NPT	805201005	M. APM 13 1/2 NPT
Nipple	1/2	3/4	NPT	805201007	M. APM 13 3/4 NPT
Nipple	5/8	3/4	NPT	805201009	M. APM 15 3/4 NPT
Nipple	3/4	3/4	NPT	805201019	M. APM 17 3/4 NPT
Nipple	3/4	1	NPT	805201011	M. APM 17 1" NPT
Nipple	1	1 1/4	NPT	805201017	M. APM 21 114 NPT
Nipple	1 1/2	1 1/2	NPT	805201015	M. APM 30 112 NPT



ISO 16028 Interchange: Nipple Connect Under Pressure Series: APM-8052

Part	Body Size	Port Size	Thread Type	Order Code	Part Description
Nipple	3/8	1/2	SAE	805204001	M. APM 9 1/2 SAE
Nipple	1/2	5/8	SAE	805204003	M. APM 13 5/8 SAE
Nipple	1/2	1/2	SAE	805204025	M. APM 13 1/2 SAE
Nipple	1/2	3/4	SAE	805204005	M. APM 13 3/4 SAE
Nipple	5/8	3/4	SAE	805204007	M. APM 15 3/4 SAE
Nipple	3/4	3/4	SAE	805204027	M. APM 17 3/4 SAE
Nipple	3/4	1	SAE	805204009	M. APM 17 1" SAE
Nipple	1	1 1/4	SAE	805204017	M. APM 21 114 SAE
Nipple	1 1/2	1 1/2	SAE	805204015	M. APM 30 112 SAE
Nipple	1/2	5/8	ORFS BH	805213001	M. APM 13 5/8 ORFS BH
Nipple	1/2	5/8	JIC BH	805206001	M. APM 13 5/8 JIC BH



ISO 16028 Interchange: Nipple Connect Under Pressure Series: APM-8052

Part	Body Size	Port Size	Thread Type	Order Code	Part Description
Nipple	3/8	3/8	BSP	805200001	M. APM 9 3/8 BSP
Nipple	3/8	1/2	BSP	805200003	M. APM 9 1/2 BSP
Nipple	1/2	1/2	BSP	805200005	M. APM 13 1/2 BSP
Nipple	1/2	3/4	BSP	805200007	M. APM 13 3/4 BSP
Nipple	5/8	3/4	BSP	805200009	M. APM 15 3/4 BSP
Nipple	3/4	1	BSP	805200011	M. APM 17 1" BSP



ISO 16028 Interchange Couplings Connect Under Pressure Female



Series: A-HD

Interchange: ISO 16028

Female coupling "A-HD" series is the Stucchi solution to the problem of the connection in the presence of high internal residual pressure. The Stucchi internal valving allows the "A-HD" series to solve the problem of manual connections in the presence of high residual pressure. The "A-HD" series Female Couplers are in accordance with **ISO 16028** for interchangeability & performance.

Connect Under Residual Pressure Female Coupler

- Visual ID: Black Ring on Coupler Face
- Zinc Plated Hardened Steel
- Seals: Nitrile / Teflon Standard
- NPT-SAE Standard Ports, Others per request
- Connect with ISO 16028 Nipple
- Connect up to 1595 psi residual pressure

Overview: Stucchi A-HD (formerly ASP) Series Female Couplings will connect by hand with residual pressure of 1500 psi locked in the hydraulic circuit. It will connect with residual pressure without releasing any fluid into the environment. The mating circuit will need to be without residual pressure.* Contact your customer service rep for more details.

Applications: Mobile equipment & attachment tools where exposure to the sun, or temperature change causes pressure to develop due to thermal expansion of trapped fluid. Any application where static pressure can get locked into the system.

Advantages:

- Visual ID: Black Ring on Face of Coupler
- Connects Under Pressure by hand: 1595 psi
- No air inclusion during connection
- Bi-Directional Flow
- Elimination of fluid loss during connection or disconnection.
- Easily cleaned before connection
- Interchangeable with ISO 16028

Operation: To Connect, wipe the mating surfaces clean, align the coupling & nipple, push together. To Disconnect, pull back the sleeve on the female and the couplers release.

Stucchi Series	Nominal Size Inches	ISO Size MM	MAX OPERATING PRESSURE COUPLED bar	MAX OPERATING PRESSURE COUPLED PSI
A13HD	1/2	12.5	330	4714



Interchange: Female Connect Under Pressure ISO 16028 Interchange Series: A-HD

Part	Body Size	Port Size	Thread Type	Order Code	Part Description
Coupler	1/2	1/2	NPT	806801000	F. A13HD 1/2 NPT
Coupler	1/2	3/4	NPT	806801002	F. A13HD 3/4 NPT
Coupler	1/2	3/4	SAE	806804000	F. A13HD 3/4 SAE
Coupler	1/2	5/8	SAE	806804006	F. A13HD 5/8 SAE
Coupler	1/2	5/8	JIC BH	806806000	F. A13HD 5/8 JIC BH



Visual Identification:

^



Black Ring on the Face of the Coupler

ISO 16028 Interchange Flat Face Push Pull

The "Push-Pull" Coupler is built on the A Premier platform, thus allowing "breakaway" capabilities when the coupler is unintentionally left coupled. It is mounted in a clamp fixture, that is designed to be fixed mounted to the structure and when pulled apart in line with the coupler, the PPC Series coupler will breakaway. It is recommended to use the APM series nipple in conjunction with this series for mobile applications.

Applications; refuse compactor/power units, trailer dump connections, snow plow application, agricultural implements.



Body Size	Port Size	Thread Type	Order Code	Part Description
3/8	1/2	NPT	PPC0608FO	Push Pull FF 3/8 x 1/2 SAE
1/2	1/2	NPT	PPC0808FP	Push Pull FF 1/2 x 1/2 NPT
1/2	3/4	SAE	PPC0812FO	Push Pull FF 1/2 x 3/4 SAE
1/2	3/4	NPT	PPC0812FP	Push Pull FF 1/2 x 3/4 NPT
5/8	3/4	SAE	PPC1012FO	Push Pull FF 5/8 x 3/4 SAE
5/8	3/4	NPT	PPC1012FP	Push Pull FF 5/8 x 3/4 NPT
3/4	3/4	NPT	PPC1212FP	Push Pull FF 3/4 x 3/4 NPT
3/4	1	NPT	PPC1216FP	Push Pull FF 3/4 x 1" NPT

(*PPC Series Consists of Coupler and clamp assembly components)



Call us at 847-956-9720, Fax at 847-956-9723, or visit us on the web www.stucchiusa.com

ISO 16028 Interchange Couplings 316 Stainless Steel



Overview:

FL Series have been designed for corrosive environments or the transmission of corrosive fluids. FM Series have been designed for hydraulic applications and offshore applications involving high salt or corrosive environments. FM Series suitable for use at depths of 1000m when connected.

Features & Options:

- No air inclusion during connection
- Flat Face can easily be cleaned limiting contamination into system
- Non-Spill design eliminates leaks
- Minimal pressure drop design
- Springs in AISI 302 stainless steel
- Balls in AISI 316
- Anti-extrusion rings are in pure Teflon
- Standard threads are BSP and NPT: other threads are available on demand
- Standard seals: VITON

Series: FL Series: FM FL Series – 316 SS

The “FL” variation of the “FIRG” series is the Stucchi Solution for high corrosion applications. The resistance to corrosion & excellent fatigue life make this product ideal for applications in chemicals, pharmaceutical, food and offshore. The interchangeability of “FL” series couplings is in accordance with **ISO 16028**.

Interchange: ISO 16028 FM Series – 316 SS w/QPQ

The “FM” is the solution for offshore marine hydraulic applications. Ideal for all under water applications, FM has added QPQ treatment for a higher working pressure. Interchange with **ISO 16028**.

Stucchi Series	Nominal Size Inches	ISO Size MM	MAX OPERATING PRESSURE COUPLED FL Series bar	MAX OPERATING PRESSURE COUPLED FM Series bar
FL4/FM4	1/8	5.0	330	Not Available
FL7/FM7	1/4	6.3	250	350
FL9/FM9	3/8	10.0	250	350
FL13/FM13	1/2	12.5	200	350
FL15/FM15	5/8	16.0	200	350
FL17/FM17	3/4	19.0	200	330
FL21/FM21	1	25.0	160	280
FL27/FM27	1 ½	31.5	125	230
FL45/FM45	2	40.0	100	Not Available

ISO 16028 Interchange Couplings 316 Stainless Steel

Item	Body Size	Size (MM)	A inch	B (mm)	C (mm)	D (mm)	E (mm)	F (mm)	G (mm)	I (mm)
FL7	1/4"	6.3	1/4"	47.9	28	48.1	85.2	23.8	23.8	16.2
FL9	3/8"	10	3/8"	60	32	64.2	108.7	26	29	19.8
FL9	3/8"	10	1/2"	62.5	32	69.2	116.2	29	29	19.8
FL13	1/2"	12.5	1/2"	68	38	73.8	124.6	33.8	33.8	24.5
FL13	1/2"	12.5	3/4"	70.5	38	80.8	134.1	38.5	38.5	24.5
FL15	5/8"	16	3/4"	70.5	42	78.5	131.5	38.5	38.5	27
FL17	3/4"	19	1"	82.5	48	93.2	153.9	47.8	47.8	30
FL21	1"	25	1 1/2"	90	55	106	173	59.8	59.8	36
FL27	1 1/2"	31.5	1 1/2"	111	80	132.4	215	72	76	57
FL45	2"	40	2"	125	100	156.6	242.8	83.5	88.5	73

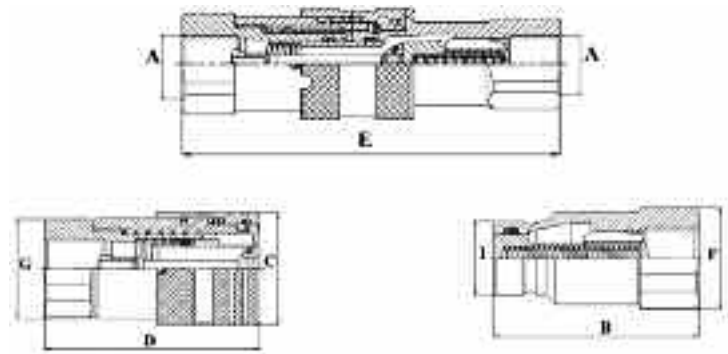
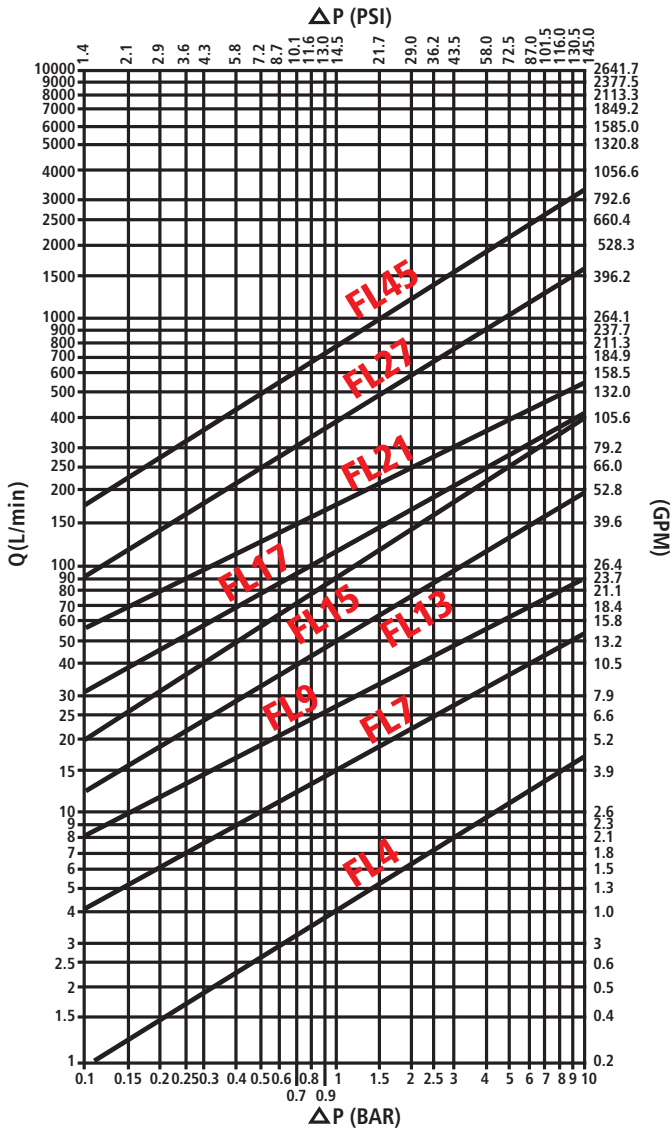

Male thread option available upon request.



ISO 16028 Interchange Series: FL – 316 Stainless

Part	Body Size	Port Size	Thread Type	Order Code	Part Description
Coupler	1/8	1/8	NPT	802401118	F. FL4 1/8 NPT
Nipple	1/8	1/8	NPT	802401119	M.FL4 1/8 NPT
Coupler	1/4	1/4	NPT	802401100	F. FL7 1/4 NPT
Nipple	1/4	1/4	NPT	802401101	M.FL7 1/4 NPT
Coupler	3/8	3/8	NPT	802401102	F. FL9 3/8 NPT
Nipple	3/8	3/8	NPT	802401103	M.FL9 3/8 NPT
Coupler	3/8	1/2	NPT	802401104	F. FL9 1/2 NPT
Nipple	3/8	1/2	NPT	802401105	M.FL9 1/2 NPT
Coupler	1/2	1/2	NPT	802401106	F. FL13 1/2 NPT
Nipple	1/2	1/2	NPT	802401107	M.FL13 1/2 NPT
Coupler	1/2	3/4	NPT	802401108	F. FL13 3/4 NPT
Nipple	1/2	3/4	NPT	802401109	M.FL13 3/4 NPT
Coupler	5/8	3/4	NPT	802401110	F. FL15 3/4 NPT
Nipple	5/8	3/4	NPT	802401111	M.FL15 3/4 NPT
Coupler	3/4	1	NPT	802401112	F. FL17 1" NPT
Nipple	3/4	1	NPT	802401113	M.FL17 1" NPT
Coupler	1	1 1/4	NPT	802401114	F. FL21 114 NPT
Nipple	1	1 1/4	NPT	802401115	M.FL21 114 NPT
Coupler	1 1/2	1 1/2	NPT	802401116	F. FL27 112 NPT
Nipple	1 1/2	1 1/2	NPT	802401117	M.FL27 112 NPT
Coupler	2	2	NPT	802401120	F. FL45 2" NPT
Nipple	2	2	NPT	802401121	M.FL45 2" NPT



Coupler



Nipple

ISO 16028 Interchange Series: FM – 316 Stainless: w/QPQ Plating

Part	Body Size	Port Size	Thread Type	Order Code	Part Description
Coupler	1/8	1/8	NPT	802301122	F. FM4 1/8 NPT
Nipple	1/8	1/8	NPT	802301123	M.FM4 1/8 NPT
Coupler	1/4	1/4	NPT	802301100	F. FM7 1/4 NPT
Nipple	1/4	1/4	NPT	802301101	M.FM7 1/4 NPT
Coupler	3/8	3/8	NPT	802301102	F. FM9 3/8 NPT
Nipple	3/8	3/8	NPT	802301103	M.FM9 3/8 NPT
Coupler	3/8	1/2	NPT	802301104	F. FM9 1/2 NPT
Nipple	3/8	1/2	NPT	802301105	M.FM9 1/2 NPT
Coupler	1/2	1/2	NPT	802301106	F. FM13 1/2 NPT
Nipple	1/2	1/2	NPT	802301107	M.FM13 1/2 NPT
Coupler	1/2	3/4	NPT	802301108	F. FM13 3/4 NPT
Nipple	1/2	3/4	NPT	802301109	M.FM13 3/4 NPT
Coupler	5/8	3/4	NPT	802301110	F. FM15 3/4 NPT
Nipple	5/8	3/4	NPT	802301111	M.FM15 3/4 NPT
Coupler	3/4	1	NPT	802301112	F. FM17 1" NPT
Nipple	3/4	1	NPT	802301113	M.FM17 1" NPT
Coupler	1	1 1/4	NPT	802301114	F. FM21 114 NPT
Nipple	1	1 1/4	NPT	802301115	M.FM21 114 NPT
Coupler	1 1/2	1 1/2	NPT	802301116	F. FM27 112 NPT
Nipple	1 1/2	1 1/2	NPT	802301119	M.FM27 112 NPT
Coupler	2	2	NPT	802301118	F. FM45 2" NPT
Nipple	2	2	NPT	802301121	M.FM45 2" NPT



Coupler



Nipple

ISO 16028 Interchange Couplings Flat Face w/-QPQ



Series: FIRG Q

“Q” variation of the “FIRG” series is the integration of the QPQ plating technology combined with a coupler constructed of stainless internal parts and carbon steel external parts of the flat face quick couplings. In relatively corrosive, alkaline environments they are an excellent alternative to the more expensive stainless steel quick couplings and demonstrate a much higher operational pressure performance. The interchangeability of “FIRG Q” series couplings is in accordance with ISO 16028.

Interchange: ISO 16028

- Material: high resistance carbon steel treated with QPQ
- Valve parts in stainless steel
- Springs in AISI 302 SS
- Locking Balls in AISI 420.
- Seals: Nitrile, EPDM, Viton, Etc.

Overview: Stucchi Series FIRGQ is an extension of the FIRG series that has been produced since 1984. The QPQ plating treatment is a surface hardening treatment providing a corrosion resistant finish that is superior to zinc plating in many environments. It is designed as a low cost alternative for applications where Stainless Steel is cost prohibitive.

Applications: FIRG Q Series are suitable for low and medium corrosion applications such as systems operating on mineral oil, steam, water or other low or medium corrosive fluids. Steel Mills, Tire Manufacturing, State or Municipal Right-of-Way spraying.

Product Features & Options:

- Couplings: Internal SS Parts, External Carbon with QPQ
- Seals: Nitrile with Teflon anti-extrusion ring. Viton, Kalzrez, EPDM upon request
- Ports: NPT, SAE
- Tight Tolerances ensure equal loading of couplers
- Female Seal swaged to prevent extrusion
- No air inclusion during connection
- Flat mating surface easily cleaned
- Non-spill design avoids fluid loss during connection / disconnection

Stucchi Series	Nominal Size Inches	ISO Size MM	MAX OPERATING PRESSURE COUPLED bar	MAX OPERATING PRESSURE COUPLED PSI
FIRGQ 14	1/4	6.3	300	4285
FIRGQ 38/12	3/8	10.0	300	4285
FIRGQ 12A/34	1/2	12.5	250	3571
FIRGQ 34B	5/8	16.0	250	3571
FIRGQ 100	3/4	19.0	250	3571
FIRGQ 114	1	25.0	250	3571
FIRGQ 112	1 1/2	31.5	200	2857
FIRGQ 200	2	40	200	2857



Call us at 847-956-9720, Fax at 847-956-9723, or visit us on the web www.stucchiusa.com

Item	Body Size	Size (MM)	A inch	B (mm)	C (mm)	D (mm)	E (mm)	F (mm)	G (mm)	I (mm)
FIRG 14Q	1/4"	6.3	1/4"	47.9	28	48.1	85.2	23.8	23.8	16.2
FIRG 38Q	3/8"	10	3/8"	60	32	64.2	108.7	26	29	19.8
FIRG 12Q	3/8"	10	1/2"	62.5	32	69.2	116.2	29	29	19.8
FIRG 12AQ	1/2"	12.5	1/2"	68	38	73.8	124.6	33.8	33.8	24.5
FIRG 34Q	1/2"	12.5	3/4"	70.5	38	80.8	134.1	38.5	38.5	24.5
FIRG 34BQ	5/8"	16	3/4"	70.5	42	78.5	131.5	38.5	38.5	27
FIRG 100Q	3/4"	19	1"	82.5	48	93.2	153.9	47.8	47.8	30
FIRG 114Q	1"	25	1 1/2"	90	55	106	173	59.8	59.8	36
FIRG 112Q	1 1/2"	31.5	1 1/2"	111	80	132.4	215	72	76	57
FIRG 200Q	2"	40	2"	125	100	156.6	242.8	83.5	88.5	73

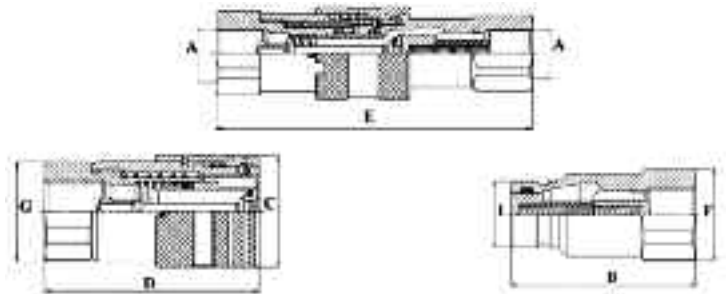
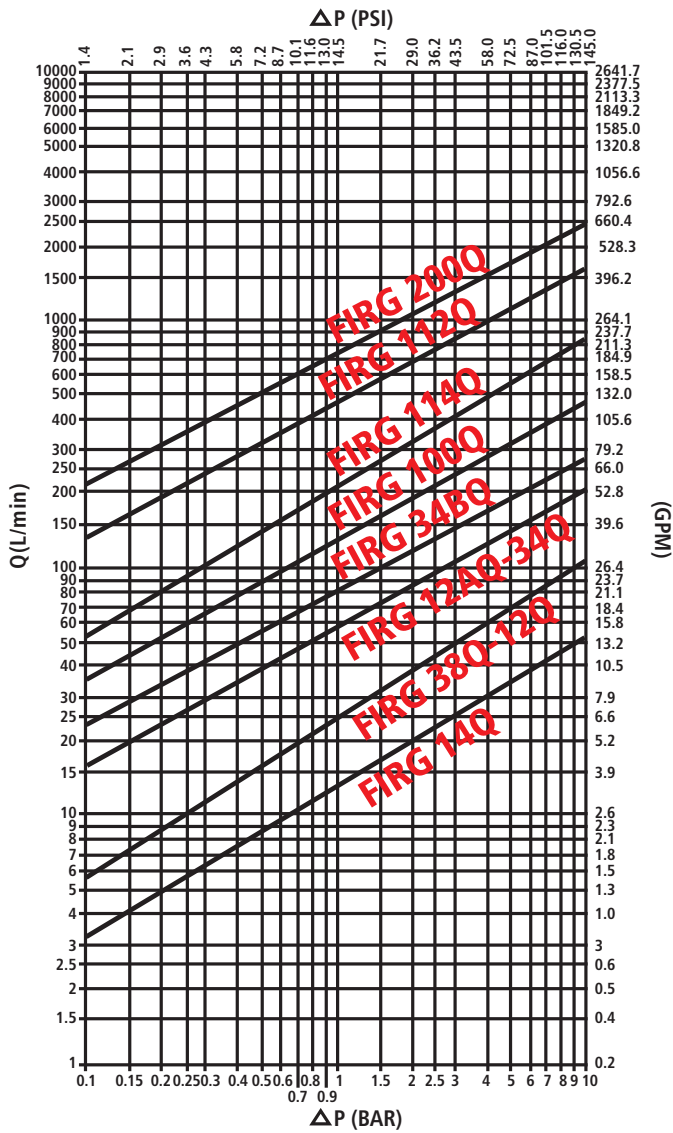

ISO 16028 Interchange Couplings Flat Face w/-QPQ

Interchange: ISO 16028 Interchange: -NPT Thread



Coupler



Nipple

Part	Body Size	Port Size	Thread Type	Order Code	Part Description
Coupler	1/4	1/4	NPT	800901000	F. FIRG 14 QN NPT
Nipple	1/4	1/4	NPT	800901001	M. FIRG 14 QN NPT
Coupler	3/8	3/8	NPT	800901002	F. FIRG 38 QN NPT
Nipple	3/8	3/8	NPT	800901003	M. FIRG 38 QN NPT
Coupler	3/8	1/2	NPT	800901004	F. FIRG 12 QN NPT
Nipple	3/8	1/2	NPT	800901005	M. FIRG 12 QN NPT
Coupler	1/2	1/2	NPT	800901006	F. FIRG 12A QN NPT
Nipple	1/2	1/2	NPT	800901007	M. FIRG 12A QN NPT
Coupler	1/2	3/4	NPT	800901008	F. FIRG 34 QN NPT
Nipple	1/2	3/4	NPT	800901009	M. FIRG 34 QN NPT
Coupler	5/8	3/4	NPT	800901010	F. FIRG 34B QN NPT
Nipple	5/8	3/4	NPT	800901011	M. FIRG 34B QN NPT
Coupler	3/4	1	NPT	800901012	F. FIRG 100 QN NPT
Nipple	3/4	1	NPT	800901013	M. FIRG 100 QN NPT
Coupler	1	1 1/4	NPT	800901014	F. FIRG 114 QN NPT
Nipple	1	1 1/4	NPT	800901015	M. FIRG 114 QN NPT
Coupler	1 1/2	1 1/2	NPT	800901016	F. FIRG 112 QN NPT
Nipple	1 1/2	1 1/2	NPT	800901017	M. FIRG 112 QN NPT
Coupler	2	2	NPT	800901018	F. FIRG 200 QN NPT
Nipple	2	2	NPT	800901019	M. FIRG 200 QN NPT



Caps & Plugs available: Pg. 73



Stucchi

Call us at 847-956-9720, Fax at 847-956-9723, or visit us on the web www.stucchiusa.com

ISO 16028 Interchange Flat Face w/ Special Z Plating



Overview:

"A" Series or Premier Z Series offers higher pressure ratings, superior flow ratings, lower pressure drop compared to competitors products. Specialized plating for high corrosion resistance designed to exceed 400 hours in the ISO Salt Spray test before the appearance of red spots.

Applications:

Flat Face couplers are specifically designed for applications needing no-leak performance. The mating faces are easily cleaned before connecting, making it the ideal solution for limiting contamination in a hydraulic circuit. The Z version design allows for applications involving medium to high corrosion environments.

Interchange: ISO 16028 Flat Face

"A" series couplings are in accordance for *Interchangeability* and *performances* of ISO 16028. The Z version is an integration of plating technology that exceeds the ISO salt spray test. Standard zinc plating is guaranteed for 72 hours before red spotting. The Z version plating is designed to exceed 400 hours before the appearance of redspotting in the same ISO salt spray test.

- Seals: Nitrile & Teflon anti-extrusion
- Nipple: Hardened steel reduces brinnelling
- 12 to 20 balls to increase the male bearing points & decrease the brinelling effect
- Modular structure for multiple port option
- Lock system stops unwanted disconnect
- Exceeds Impulse test of ISOA-7241 test

Stucchi Series	Nominal Size Inches	ISO Size MM	MAX OPERATING PRESSURE COUPLED bar	MAX OPERATING PRESSURE COUPLED PSI
A9ZF	3/8	10.0	350	5000
A13ZF	1/2	12.5	330	4714
A15ZF	5/8	16.0	330	4714
A17ZF	3/4	19.0	330	4714
A21ZF	1	25.0	300	4286

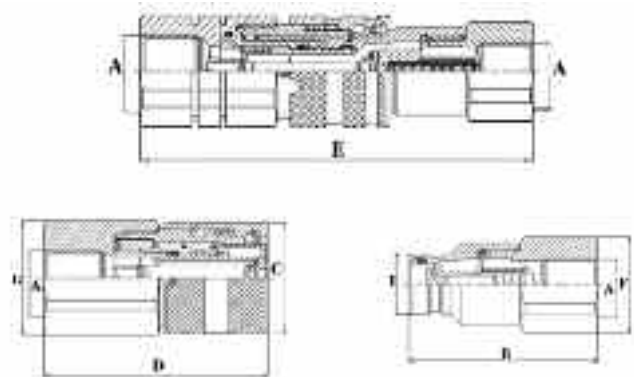

ISO 16028 Interchange Flat Face w/ Special Z Plating

ISO 16028 Interchange: -NPT Thread



Coupler



Nipple

Part	Body Size	Port Size	Thread Type	Order Code	Part Description
Coupler	3/8	3/8	NPT	807601007	F. A9ZF 3/8 NPT
Nipple	3/8	3/8	NPT	807601008	M. A9ZF 3/8 NPT
Coupler	1/2	1/2	NPT	807601008	F. A13ZF 1/2 NPT
Nipple	1/2	1/2	NPT	807601009	M. A13ZF 1/2 NPT
Coupler	1/2	3/4	NPT	807601010	F. A13ZF 3/4 NPT
Nipple	1/2	3/4	NPT	807601011	M. A13ZF 3/4 NPT
Coupler	5/8	3/4	NPT	807601012	F. A15ZF 3/4 NPT
Nipple	5/8	3/4	NPT	807601013	M. A15ZF 3/4 NPT

Item	Body Size	Size (MM)	A inch	B (mm)	C (mm)	D (mm)	E (mm)	F (mm)	G (mm)	I (mm)
A9ZF	3/8"	10	3/8"	60	32	64.5	109	29	32	19.8
A13ZF	1/2"	12.5	1/2"	68	38	76.5	127.5	40	40	24.5
A13ZF	1/2"	12.5	3/4"	70.5	38	83.5	137	40	40	24.5
A15ZF	5/8"	16	3/4"	73	42	83.5	139.5	38.5	45	27
A17ZF	3/4"	19	1"	84	48	98.5	161	50	50	30
A21ZF	1"	21	1 1/4"	90	55	105	173	60	60	36

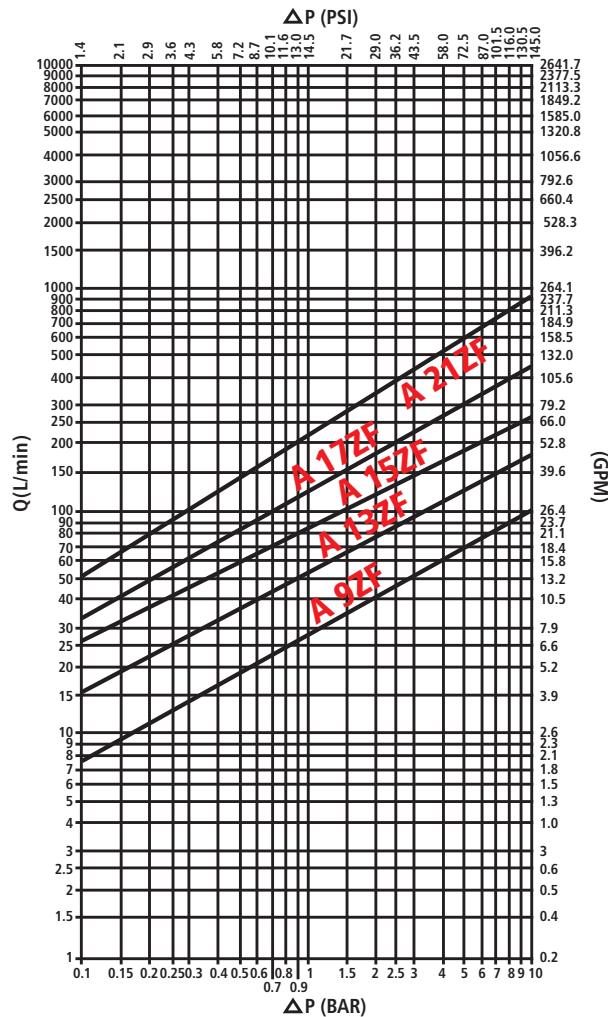

Call us at 847-956-9720, Fax at 847-956-9723, or visit us on the web www.stucchiusa.com

Flat Face Coupling 10,000 Working Pressure



Overview: The Stucchi HP series offers a patented safety system to prevent accidental disconnection. This patented sleeve system automatically rotates the sleeve when connected, engaging the safety lock mechanism. To disconnect: the coupler sleeve must be turned and aligned between the release notch and locking pin. A simple yet highly effective safety system.

Advantages:

- Locking sleeve eliminates accidental disconnection
- Low Pressure drop
- No air inclusion during connection
- Flat-Face design limits leakage
- Easy to clean, eliminate contamination of hydraulic circuit
- Bi-Directional flow
- Seals: Nitrile o-ring w/ anti extrusion rings in specially shaped Teflon (PTFE)

Series: A_HP

General data: "HP" is the Stucchi Solution to High Pressure leak free applications with a **10,000 psi working pressure**.

Features Include:

- Auto lock sleeve to eliminate accidental disconnection
- Does not interchange with lower pressure couplings to avoid misuse

Interchange: None -Proprietary Coupling

Applications: Emergency Cutting tools, hydraulic wrenches, tools

Nominal Size Inch	ISO Size MM	MAX Working Pressure bar	MAX Working Pressure PSI
1/8	5	720	10,000
1/4	6.3	720	10,000
3/8	10	720	10,000

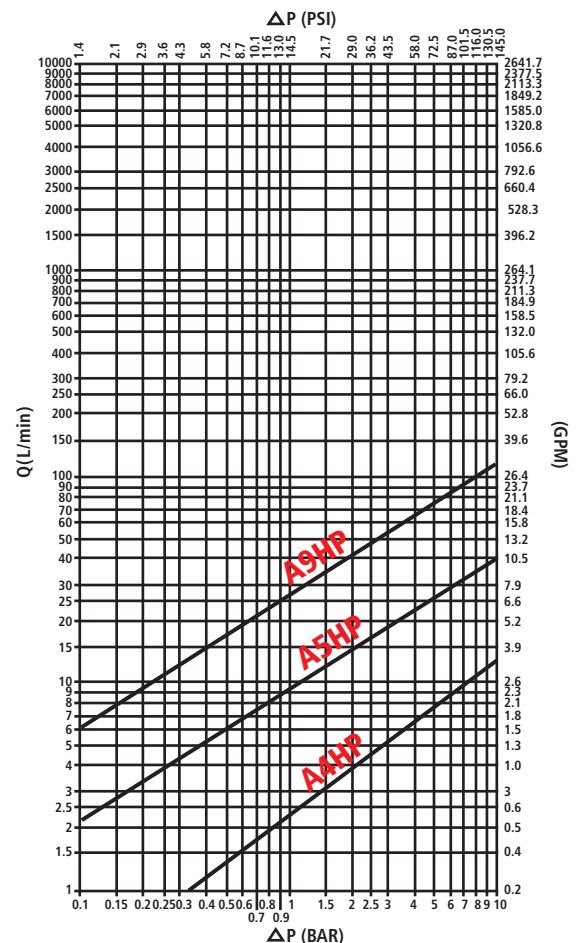

Flat Face Coupling 10,000 Working Pressure

Interchange: None Series: A_HP – 10,000 PSI



Coupler



Nipple

Part	Body Size	Port Size	Thread Type	Order Code	Part Description
Coupler	1/8	1/8	Female NPT	801601014	F. A4 HP 1/8 NPT
Nipple	1/8	1/8	Female NPT	801601015	M.A4 HP 1/8 NPT
Coupler	1/4	1/4	Female NPT	801601004	F. A5 HP 1/4 NPT
Nipple	1/4	1/4	Female NPT	801601005	M.A5 HP 1/4 NPT
Coupler	1/4	3/8	Female NPT	801601008	F. A5 HP 3/8 NPT
Nipple	1/4	3/8	Female NPT	801601009	M.A5 HP 3/8 NPT
Coupler	3/8	3/8	Female NPT	801601010	F. A9 HP 3/8 NPT
Nipple	3/8	3/8	Female NPT	801601011	M.A9 HP 3/8 NPT
Coupler	3/8	1/2	Female NPT	801601012	F. A9 HP 1/2 NPT
Nipple	3/8	1/2	Female NPT	801601013	M.A9 HP 1/2 NPT

Item	Body Size	Size (MM)	A inch	B (mm)	C (mm)	D (mm)	E (mm)	F (mm)	G (mm)
A4	1/8"	4	1/8"	74.6	38.5	18.3	22	44	18.5
A5	1/4"	5.5	1/4"	95	47.9	23.8	29	58	23.8
A5	1/4"	5.5	3/8"	99	54.9	26	29	60	26
A9	3/8"	8	3/8"	114	61	29	34	70	32
A9	3/8"	8	1/2"	115.5	62.5	29	34	70	32

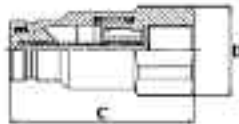
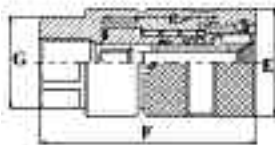
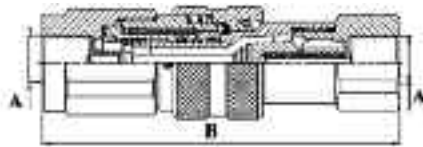

Color coded ID option available upon request.



Call us at 847-956-9720, Fax at 847-956-9723, or visit us on the web www.stucchiusa.com

Threaded Flat Face Couplings Connect Under Pressure



Series: VEP

VEP Series:

- High working pressures: 400-600 bar range based on size.
- Thread coupling system eliminates brinelling, premature leakage
- Connect / disconnect under residual pressure up to 300 bar
- Valve limits fluid movement during connection avoiding damage to other elements of circuit.
- Low connection force required

- Fire Tested and Lloyd's Certified in compliance with API 16D Test and EUB Directive 36.
(Lloyd's document available upon request)

Overview: Stucchi VEP Series is the ultimate solution most popular to hydraulic circuit applications subject to high pressure impulses, and circuits which experience high residual or trapped pressure in a line. The VEP thread to connect design eliminates premature wear or brinelling associated with locking ball designs subjected to high impulse pressures. The *patented internal valve allows connection and disconnection* with high residual pressures. Flat-Face design avoids loss of hydraulic fluid during connection / disconnection. Flat-Face design is easy to clean, limiting contamination into the circuit.

Applications & Features:

- Excavators w/ auxiliary line for attachments: Thumbs, Grapples, Hammers, and Compactors/Hopaks.
- Oil Field, Well Head Drives, Porta-Power.
- Cranes, Drilling machines, all large equipment needing junction points in circuit.
- All construction equipment applications with higher pressure requirements or issues of connecting / disconnecting tool attachments under residual pressure.
- Connect/Disconnect up to 300 bar residual pressure.
- Save time changing tools.

Stucchi Series	Nominal Size	ISO Size	MAX OPERATING PRESSURE COUPLED	MAX OPERATING PRESSURE COUPLED
VEP	Inches	MM	bar	PSI
VEP7	1/4	6.3	600	8571
VEP9	3/8	10.0	550	7857
VEP13	1/2	12.5	550	7857
VEP15	3/4	16.0	550	7857
VEP17	1	19.0	500	7142
VEP21	1 ½	25.0	470	6714
VEP30	1 ½	31.5	400	5714
VEP 45	2	42	350	5076

Threaded Flat Face Couplings Connect Under Pressure

Item	Body Size	Size (MM)	A inch	B (mm)	C (mm)	D (mm)	E (mm)	F (mm)	G (mm)	I (mm)
VEP 7	1/4"	6.3	1/4"	71	29	54.1	90	24	38.8	M30x2
VEP 9	3/8"	10	3/8"	82.5	32	65.8	131	29	41.8	M33X2
VEP 9	3/8"	10	1/2"	82.5	32	65.8	131	29	41.8	M33X2
VEP 13	1/2"	12.5	1/2"	95	45.8	77.8	155	40	49.8	M40X2
VEP 13	1/2"	12.5	3/4"	100	45.8	77.8	160	40	49.8	M40X2
VEP 15	3/4"	16	3/4"	99	44.9	84.9	165	38.5	53.3	M46X3
VEP 17	1	19	1	113.6	49.8	99.7	190.4	49.8	54.8	M50X3
VEP 21	1 1/2"	25	1 1/2"	123.4	59.8	106.8	170	64.5	69.8	M58X3
VEP 30	1 1/2"	31.5	1 1/2"	150	89.8	133.5	256	82	92	M72X4
VEP 45	2	40	2	218.4	112	204.8	363.5	120	200	M130X3

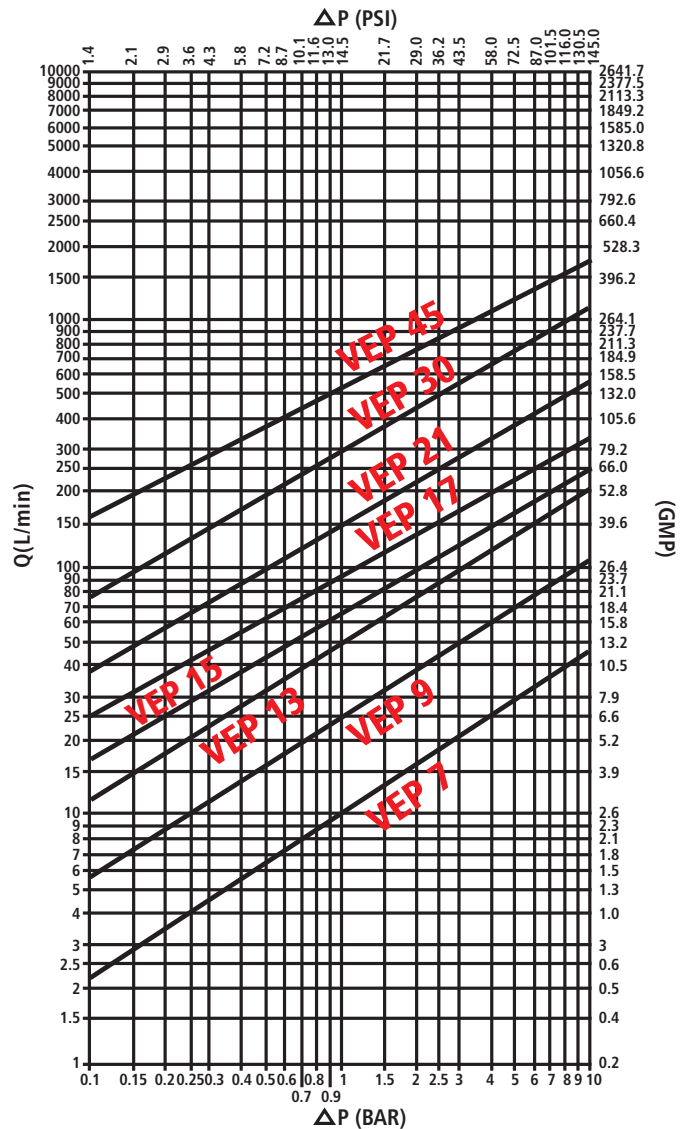
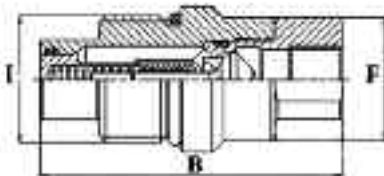
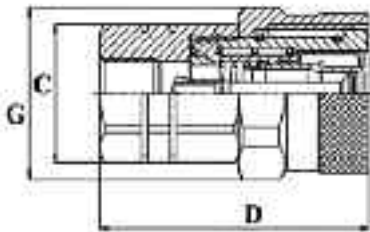
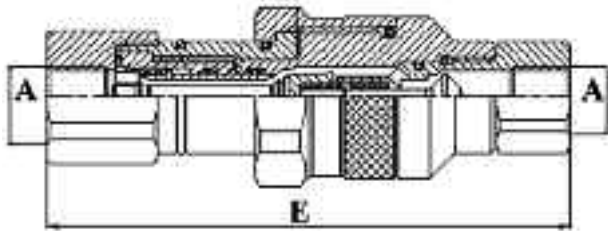

Call us at 847-956-9720, Fax at 847-956-9723, or visit us on the web www.stucchiusa.com

Flat-Face Thread Coupling connect w/ High Residual Pressure Series: VEP-NPT Thread

Part	Body Size	Port Size	Thread Type	Order Code	Part Description
Coupler	1/4	1/4	NPT	806501008	F.VEP7 1/4 NPT
Nipple	1/4	1/4	NPT	806501009	M.VEP7 1/4 NPT
Coupler	3/8	3/8	NPT	806501002	F.VEP9 3/8 NPT
Nipple	3/8	3/8	NPT	806501003	M.VEP9 3/8 NPT
Coupler	3/8	1/2	NPT	806501014	F.VEP9 1/2 NPT
Nipple	3/8	1/2	NPT	806501015	M.VEP9 1/2 NPT
Coupler	1/2	1/2	NPT	806501000	F.VEP13 1/2 NPT
Nipple	1/2	1/2	NPT	806501001	M.VEP13 1/2 NPT
Coupler	1/2	3/4	NPT	806501016	F.VEP13 3/4 NPT
Nipple	1/2	3/4	NPT	806501017	M.VEP13 3/4 NPT
Coupler	3/4	3/4	NPT	806501004	F.VEP15 3/4 NPT
Nipple	3/4	3/4	NPT	806501005	M.VEP15 3/4 NPT
Coupler	1	1	NPT	806501006	F.VEP17 1" NPT
Nipple	1	1	NPT	806501007	M.VEP17 1" NPT
Coupler	1 1/4	1 1/4	NPT	806501010	F.VEP21 114 NPT
Nipple	1 1/4	1 1/4	NPT	806501011	M.VEP21 114 NPT
Coupler	1 1/2	1 1/2	NPT	806501012	F.VEP30 112 NPT
Nipple	1 1/2	1 1/2	NPT	806501013	M.VEP30 112 NPT
Coupler	2	2	NPT	807201018	F.VEP45 2" NPT
Nipple	2	2	NPT	807201019	M.VEP45 2" NPT



Coupler



Nipple

Flat-Face Thread Coupling connect w/ High Residual Pressure Series: VEP-SAE Thread

Part	Body Size	Port Size	Thread Type	Order Code	Part Description
Coupler	3/8	1/2	SAE	806504000	F.VEP 9 1/2 SAE
Nipple	3/8	1/2	SAE	806504001	M.VEP 9 1/2 SAE
Coupler	1/2	3/4	SAE	806504004	F.VEP 13 3/4 SAE
Nipple	1/2	3/4	SAE	806504005	M.VEP 13 3/4 SAE
Coupler	3/4	3/4	SAE	806504006	F.VEP 15 3/4 SAE
Nipple	3/4	3/4	SAE	806504007	M.VEP 15 3/4 SAE
Coupler	1	1	SAE	806504002	F.VEP 17 1" SAE
Nipple	1	1	SAE	806504003	M.VEP 17 1" SAE
Coupler	1 1/4	1 1/4	SAE	806504010	F.VEP21 114 SAE
Nipple	1 1/4	1 1/4	SAE	806504011	M.VEP21 114 SAE
Coupler	1 1/2	1 1/2	SAE	806504012	F.VEP30 112 SAE
Nipple	1 1/2	1 1/2	SAE	806504013	M.VEP30 112 SAE
Coupler	2	2	SAE	807204018	F.VEP45 2" SAE
Nipple	2	2	SAE	807204019	M.VEP45 2" SAE
Coupler	2	2	Flange	807224020	F.VEP45 2" Code 62 FP
Nipple	2	2	Flange	807224021	M.VEP45 2" Code 62 FP



Coupler



Nipple

Caps & Plugs Available: Page 74

Threaded Flat Face Couplings Connect Under Pressure



Series: VEP HD

VEP HD Series:

- High working pressures: 400-500 bar range based on size.
- Threaded coupling system eliminates brinelling, premature leakage
- Connect / disconnect under residual pressure up to 300 bar
- Valve limits fluid movement during connection avoiding damage to other elements of circuit.
- Low connection force required

Overview: Stucchi VEP HD Series is the ultimate solution most popular to hydraulic circuit applications subject to high pressure impulses, and circuits which experience high residual or trapped pressure in a line. The VEP HD thread to connect design eliminates premature wear or brinelling associated with locking ball designs subjected to high impulse pressures. New HD version has upgrade of material, yellow o-ring visual ID, and larger mating areas. The *patented internal valve* allows *connection and disconnection* with high residual pressures. Flat-Face design avoids loss of hydraulic fluid during connection / disconnection. Flat-Face design is easy to clean, limiting contamination into the circuit.

Applications & Features:

- Interchanges with VEP Series
- Higher grade of steel for longer life, yellow o-ring visual ID, and larger mating areas.
- Excavators w/ auxiliary line for attachments: Thumbs, Grapples, Hammers, and Compactors/Hopaks
- High impulse mobile circuits.
- All construction equipment applications with higher pressure requirements or issues of connecting / disconnecting tool attachments under residual pressure.
- Connect/Disconnect up to 300 bar residual pressure.
- Save time changing tools.

Stucchi Series	Nominal Size	ISO Size	MAX OPERATING PRESSURE COUPLED	MAX OPERATING PRESSURE COUPLED
VEP	Inches	MM	bar	PSI
VEP17HD	1	19.0	500	7142
VEP21HD	1 ¼	25.0	470	6714
VEP30HD	1 ½	31.5	400	5714



Call us at 847-956-9720, Fax at 847-956-9723, or visit us on the web www.stucchiusa.com

Item	Body Size	Size (MM)	A inch	B (mm)	C (mm)	D (mm)	E (mm)	F (mm)	G (mm)	I (mm)
VEP 17HD	1	19	1	132	51.8	107.7	198.5	49.8	58.8	M50X3
VEP 21HD	1 ¼"	25	1 ¼"	133.4	61.8	110.8	198.2	59.8	69.8	M58X3
VEP 30HD	1 ½"	31.5	1 ½"	150	89.8	133.5	256	69.6	89	M72X4

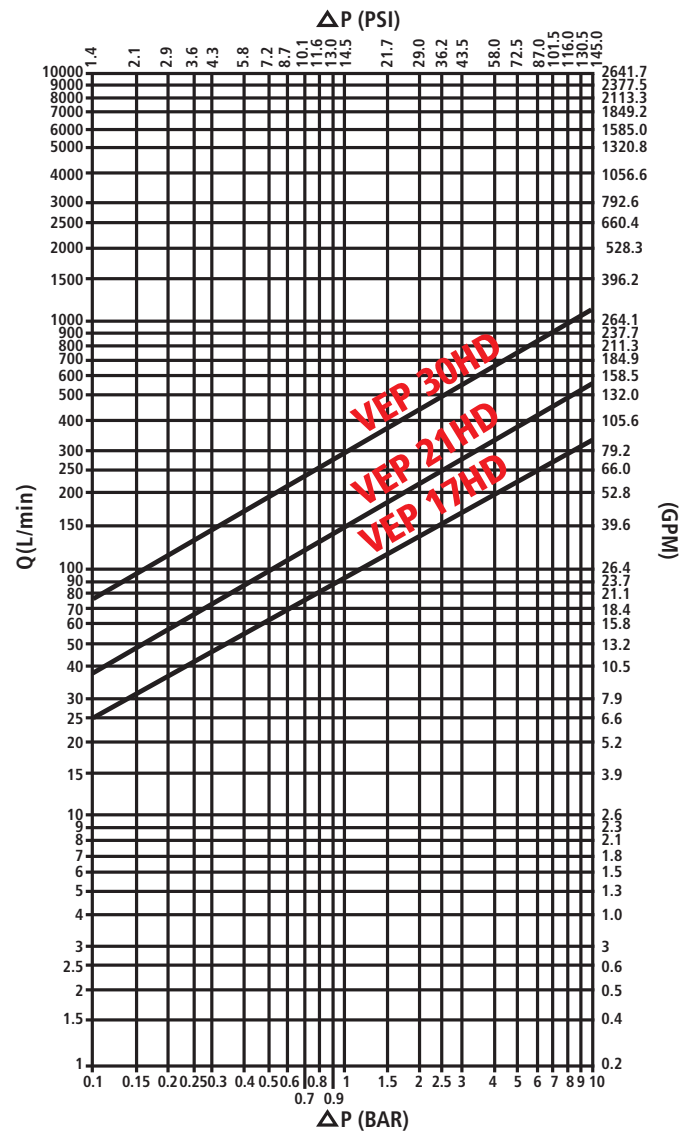
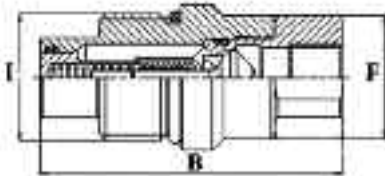
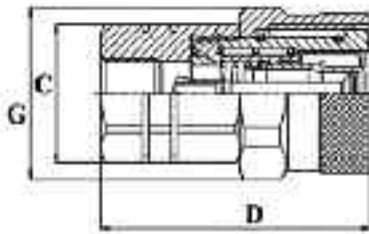
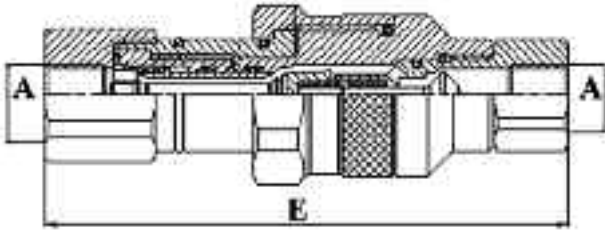

Threaded Flat Face Couplings Connect Under Pressure

Flat-Face Thread Coupling connect w/ High Residual Pressure Series: VEP HD-NPT Thread



Coupler

Part	Body Size	Port Size	Thread Type	Order Code	Part Description
Coupler	1	1	NPT	808101012	F.VEP17HD 1" NPT
Nipple	1	1	NPT	808101013	M.VEP17HD 1" NPT
Coupler	1 ¼	1 ¼	NPT	808101014	F.VEP21HD 114 NPT
Nipple	1 ¼	1 ¼	NPT	808101015	M.VEP21HD 114 NPT
Coupler	1 ½	1 ½	NPT	808101016	F.VEP30HD 112 NPT
Nipple	1 ½	1 ½	NPT	808101017	M.VEP30HD 112 NPT

Flat-Face Thread Coupling connect w/ High Residual Pressure Series: VEP HD-SAE Thread



Nipple

Part	Body Size	Port Size	Thread Type	Order Code	Part Description
Coupler	1	1	SAE	808104012	F.VEP17HD 1" SAE
Nipple	1	1	SAE	808104013	M.VEP17HD 1" SAE
Coupler	1 ¼	1 ¼	SAE	808104014	F.VEP21HD 114 SAE
Nipple	1 ¼	1 ¼	SAE	808104015	M.VEP21HD 114 SAE
Coupler	1 ½	1 ½	SAE	808104016	F.VEP30HD 112 SAE
Nipple	1 ½	1 ½	SAE	808104017	M.VEP30HD 112 SAE

Caps & Plugs Available: Page 74



Threaded Flat Face Couplings Connect Under Pressure



Series: VP

VP Series:

- High working pressures: 400-600 bar range based on size.
- Thread coupling system eliminates brinelling, premature leakage
- Connect / disconnect under residual pressure up to 300 bar
- Valve limits fluid movement during connection avoiding damage to other elements of circuit.
- Low connection force required
- Safety Auto-Lock feature upon connecting.

- Fire Tested and Lloyd's Certified in compliance with API 16D Test and EUB Directive 36. (Lloyd's document available upon request)

Overview: Stucchi VP Series is the ultimate solution most popular to hydraulic circuit applications subject to high pressure impulses, and circuits which experience high residual or trapped pressure in a line. The VP thread to connect design eliminates premature wear or brinelling associated with locking ball designs subjected to high impulse pressures. The *patented internal valve* allows *connection and disconnection* with high residual pressures. Flat-Face design avoids loss of hydraulic fluid during connection / disconnection. Flat-Face design is easy to clean, limiting contamination into the circuit.

Applications & Features:

- Excavators w/ auxiliary line for attachments: Thumbs, Grapples, Hammers.
- Oil Field, Well Head Drives, Porta-Power.
- Cranes, Drilling machines, all large equipment needing junction points in circuit.
- All construction equipment applications with higher pressure requirements or issues of connecting / disconnecting tool attachments under residual pressure.
- Connect/Disconnect up to 300 bar residual pressure.
- Save time changing tools.

Stucchi Series	Nominal Size	ISO Size	MAX OPERATING PRESSURE COUPLED	MAX OPERATING PRESSURE COUPLED
VEP	Inches	MM	bar	PSI
VP7	1/4	6.3	600	8571
VP9	3/8	10.0	550	7857
VP13	1/2	12.5	550	7857
VP15	3/4	16.0	550	7857
VP17	1	19.0	500	7142
VP21	1 ¼	25.0	470	6714
VP30	1 ½	31.5	400	5714

Threaded Flat Face Couplings Connect Under Pressure

Item	Body Size	Size (MM)	A inch	B (mm)	C (mm)	D (mm)	E (mm)	F (mm)	G (mm)	I (mm)
VP 7	1/4 "	6.3	1/4 "	83.9	M24x2	52.8	125.2	24	29	35
VP 9	3/8 "	10	3/8 "	94.5	M28x2	64.3	142.3	29	32	42
VP 9	3/8 "	10	1/2 "	94.5	M28x2	69.3	147.3	29	32	42
VP 13	1/2 "	12.5	1/2 "	110	M36x3	76.2	167.9	38.5	40	49
VP 13	1/2 "	12.5	3/4 "	110	M36x3	83.2	174.9	38.5	40	49
VP 15	3/4 "	16	3/4 "	110	M39x3	83.4	174.9	38.5	44.8	52
VP 17	1	19	1	127.1	M45x3	96	200.5	49.8	49.8	60
VP 21	1 1/4 "	25	1 1/4 "	137	M55x3	105	214.8	59.8	59.8	76
VP 30	1 1/2 "	31.5	1 1/2 "	174.7	G 1-1/2	132.2	271.3	69.8	72	82

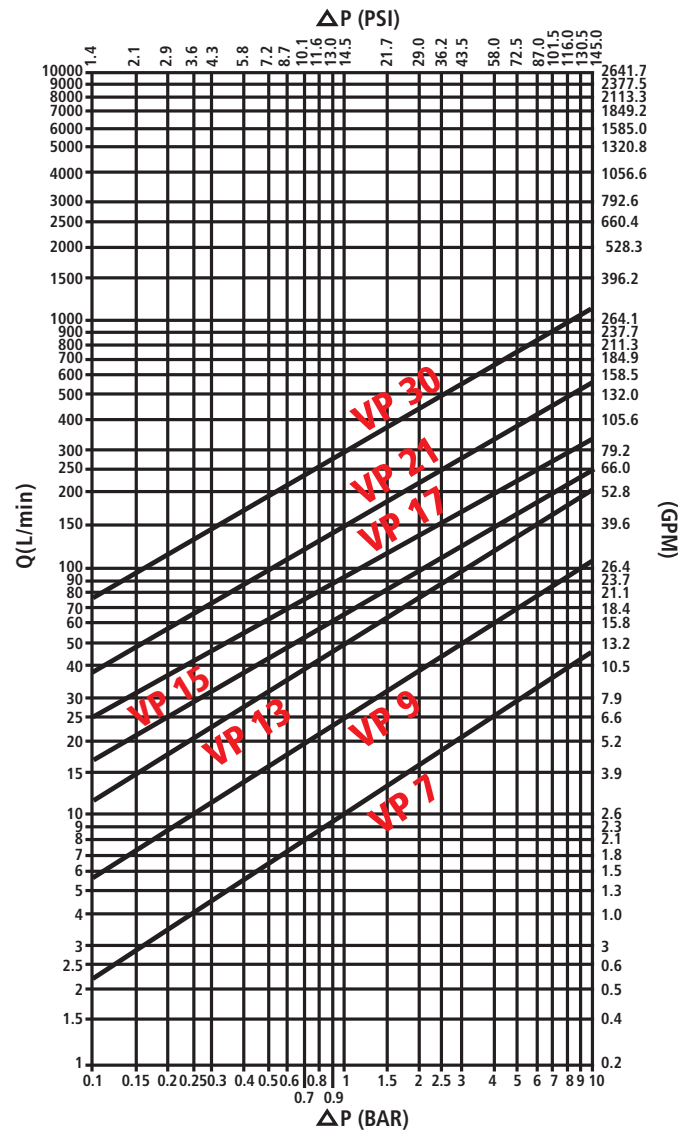
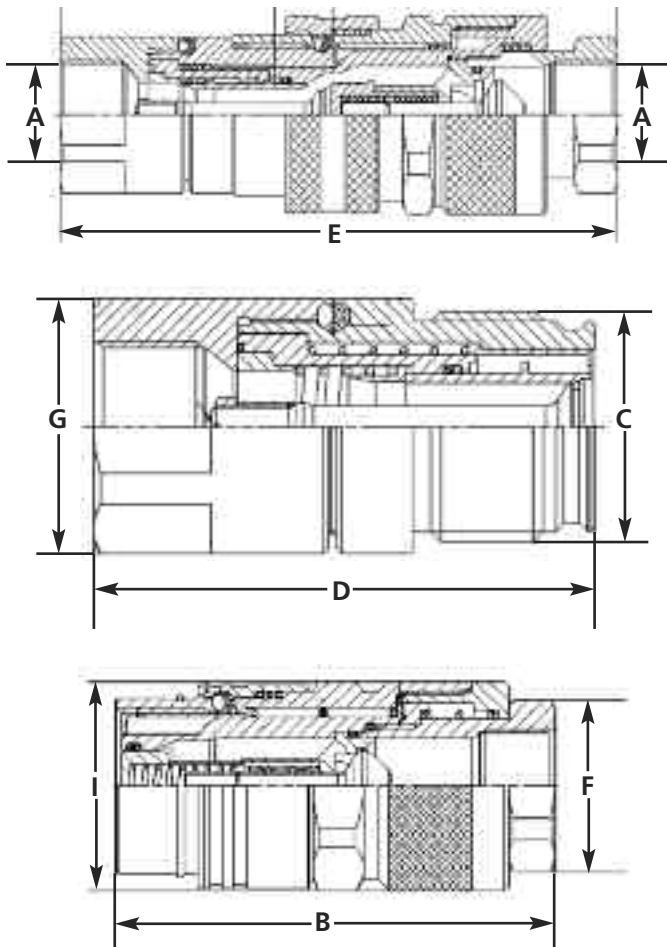

Flat-Face Thread connect w/ High Residual Pressure –Auto Lock Series: VP-NPT Thread

Part	Body Size	Port Size	Thread Type	Order Code	Part Description
Coupler	1/4	1/4	NPT	801901004	F.VP7P 1/4 NPT
Nipple	1/4	1/4	NPT	801901005	M.VP7P 1/4 NPT
Coupler	3/8	3/8	NPT	801901010	F.VP9P 3/8 NPT
Nipple	3/8	3/8	NPT	801901011	M.VP9P 3/8 NPT
Coupler	3/8	1/2	NPT	801901000	F.VP9P 1/2 NPT
Nipple	3/8	1/2	NPT	801901001	M.VP9P 1/2 NPT
Coupler	1/2	1/2	NPT	801901006	F.VP13P 1/2 NPT
Nipple	1/2	1/2	NPT	801901007	M.VP13P 1/2 NPT
Coupler	1/2	3/4	NPT	801901008	F.VP13P 3/4 NPT
Nipple	1/2	3/4	NPT	801901009	M.VP13P 3/4 NPT
Coupler	3/4	3/4	NPT	801901002	F.VP15P 3/4 NPT
Nipple	3/4	3/4	NPT	801901003	M.VP15P 3/4 NPT
Coupler	1	1	NPT	801901012	F.VP17P 1" NPT
Nipple	1	1	NPT	801901013	M.VP17P 1" NPT
Coupler	1 ¼	1 ¼	NPT	801901014	F.VP21P 114 NPT
Nipple	1 ¼	1 ¼	NPT	801901015	M.VP21P 114 NPT
Coupler	1 ½	1 ½	NPT	801901016	F.VP30P 112 NPT
Nipple	1 ½	1 ½	NPT	801901017	M.VP30P 112 NPT



Coupler



Nipple

Flat-Face Thread connect w/ High Residual Pressure –Auto Lock Series: VP-SAE Thread

Part	Body Size	Port Size	Thread Type	Order Code	Part Description
Coupler	3/8	3/8	SAE	807304020	F.VP9P 3/8 SAE
Nipple	3/8	3/8	SAE	807304021	M.VP9P 3/8 SAE
Coupler	1/2	1/2	SAE	807304022	F.VP13P 1/2 SAE
Nipple	1/2	1/2	SAE	807304023	M.VP13P 1/2 SAE
Coupler	1/2	3/4	SAE	807304008	F.VP13P 3/4 SAE
Nipple	1/2	3/4	SAE	807304009	M.VP13P 3/4 SAE
Coupler	3/4	3/4	SAE	807304010	F.VP15P 3/4 SAE
Nipple	3/4	3/4	SAE	807304011	M.VP15P 3/4 SAE
Coupler	1	1	SAE	807304012	F.VP17P 1" SAE
Nipple	1	1	SAE	807304013	M.VP17P 1" SAE
Coupler	1 ¼	1 ¼	SAE	807304014	F.VP21P 114 SAE
Nipple	1 ¼	1 ¼	SAE	807304015	M.VP21P 114 SAE
Coupler	1 ½	1 ½	SAE	807304016	F.VP30P 112 SAE
Nipple	1 ½	1 ½	SAE	807304017	M.VP30P 112 SAE



Coupler



Nipple

Caps & Plugs Available: Pg. 73

ISO-A Interchange Coupling



Overview: ISO A style couplings are one of the most popular designs worldwide used in agricultural, mobile equipment, and some industrial applications. The ISO A style is a durable product using a poppet style valve for the sealing mechanism. The Stucchi breadth of product exceeds that of most competitors by offering sizes over 1".

Technical Characteristics

- Coupling Body: zinc plated steel
- Nipple is zinc plated hardened steel
- Seals: Nitrile
- Anti extrusion rings are Teflon
- NPT standard threads
- On request BSP threads & various seals
- Anti dust plastic caps
- Clip provided "Auto Shut" Nylon caps for BIR12 female coupler part available

Series: BIR

Interchange: ISO A

"BIR" quick couplings are interchangeable according to the ISO 7241-1 series "A". They are available from size 1/4 to size 2", to cover the various fields of hydraulic applications. The series "BIR" couplings are the most used, from industrial plants to agriculture.

Interchange: Parker 6600, Aeroquip 5600, Faster ANV

- Positive-stop valving prevents flow checking
- Large diameter sleeves resist deformation
- Steel sleeves hardened for maximum life
- Suitable for "Open Center" or "Closed Center" hydraulic system

Body Size	ISO Size	MAX Operating Pressure Coupled bar	MAX Operating Pressure Coupled PSI
Inch	MM		
1/4	6.3	350	5000
3/8	10	300	4285
1/2	12.5	250	3571
3/4	20	250	3571
1	25	230	3285
1 ¼	31.5	230	3285
1 ½	40	180	2571
2	50	130	1857



Item	Body Size	Size (MM)	A inch	B (mm)	C (mm)	D (mm)	E (mm)	F (mm)	G (mm)
BIR 14	1/4"	6.3	1/4	32	26	47	64.5	21	22
BIR 38	3/8"	10	3/8	38	31	56	76.5	24	24
BIR 12	1/2"	12.5	1/2	44.5	38	63.3	86	29	30
BIR 34	3/4"	20	3/4	55	48	82	111	38.5	44
BIR 100	1"	25	1	63	54	97	127	45	52
BIR 114	1 1/4"	31.5	1 1/4	75	65	117	151	60	56
BIR 112	1 1/2"	40	1 1/2	85	80	135	171	65.5	65.5
BIR 200	2"	50	2	100	100	160	201	82.5	83.5

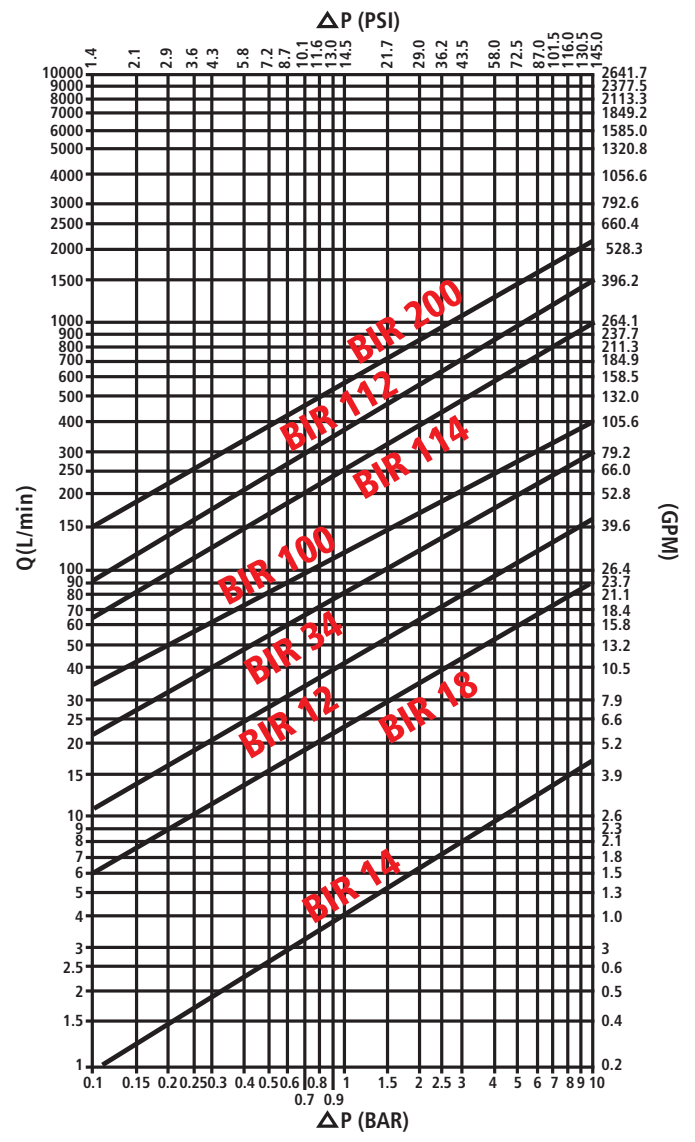
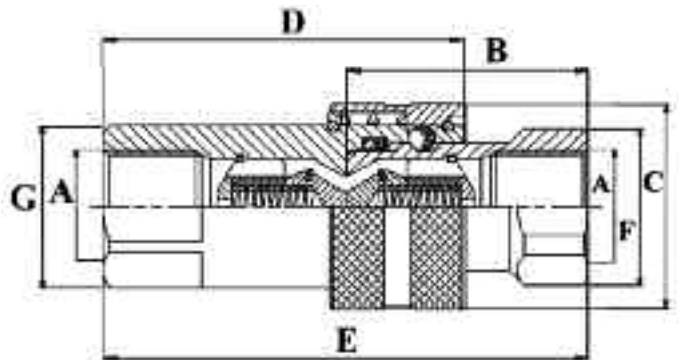

ISO-A Interchange Coupling

NPT Thread



Coupler



Nipple

Interchange: Parker 6600, Aeroquip 5600, Faster ANV ISO A Interchange: -BIR Series

Part	Body Size	Port Size	Thread Type	Order Code	Part Description
Coupler	1/4	1/4	NPT	800501000	F. BIR 14 NPT
Nipple	1/4	1/4	NPT	800501001	M. BIR 14 NPT
Coupler	3/8	3/8	NPT	800501002	F. BIR 38 NPT
Nipple	3/8	3/8	NPT	800501003	M. BIR 38 NPT
Coupler	1/2	1/2	NPT	800501004	F. BIR 12 NPT
Nipple	1/2	1/2	NPT	800501005	M. BIR 12 NPT
Coupler	3/4	3/4	NPT	800501006	F. BIR 34 NPT
Nipple	3/4	3/4	NPT	800501007	M. BIR 34 NPT
Coupler	1	1	NPT	800501008	F. BIR 100 NPT
Nipple	1	1	NPT	800501009	M. BIR 100 NPT
Coupler	1 ¼	1 ¼	NPT	800501010	F. BIR 114 NPT
Nipple	1 ¼	1 ¼	NPT	800501011	M. BIR 114 NPT
Coupler	1 ½	1 ½	NPT	800501012	F. BIR 112 NPT
Nipple	1 ½	1 ½	NPT	800501013	M. BIR 112 NPT
Coupler	2	2	NPT	800501014	F. BIR 200 NPT
Nipple	2	2	NPT	800501015	M. BIR 200 NPT

Interchange: Parker 6600, Aeroquip 5600, Faster ANV ISO A Interchange: -BIR Series

Part	Body Size	Port Size	Thread Type	Order Code	Part Description
Coupler	1/2	1/2	NPT	805601000	F. BIR 12 PC NPT*
Nipple	1/2	1/2	NPT	805601001	M. BIR 12 PC NPT*



*Connect under residual pressure poppet valve



Call us at 847-956-9720, Fax at 847-956-9723, or visit us on the web www.stucchiusa.com

ISO B Interchange



Technical Characteristics & Options

- NPT standard threads
- Anti extrusion rings are in pure Teflon (PTFE)
- Springs in AISI 302 stainless steel
- On request BSP threads and various seals.

Body Size	ISO Size	MAX OPERATING PRESSURE COUPLED IRB		MAX OPERATING PRESSURE COUPLED IRBO		MAX OPERATING PRESSURE COUPLED IRBX	
		bar	PSI	bar	PSI	bar	PSI
1/8	5.0	350	5076	200	2900	250	3625
1/4	6.3	350	5076	200	2900	250	3625
3/8	10.0	300	4351	160	2320	200	2900
1/2	12.5	280	4061	160	2320	200	2900
3/4	20.0	230	3335	125	1812	160	2320
1	25.0	150	2175	100	1450	125	1812

Series: IRB, IRBO, IRBX Interchange: ISO B

The series "IRB" quick couplings, are interchangeable to ISO 7241-1 series "B". The series "IRB" most important characteristics are compactness, and highest quality raw material used to manufacture.

Interchange: Parker 60, Aeroquip FD45, Faster HNV

- IRB – Carbon Steel Material w/ Nitrile Seals
- IRBO – Brass material w/ Viton Seals
- IRBX – 316 SS w/ Viton Seals

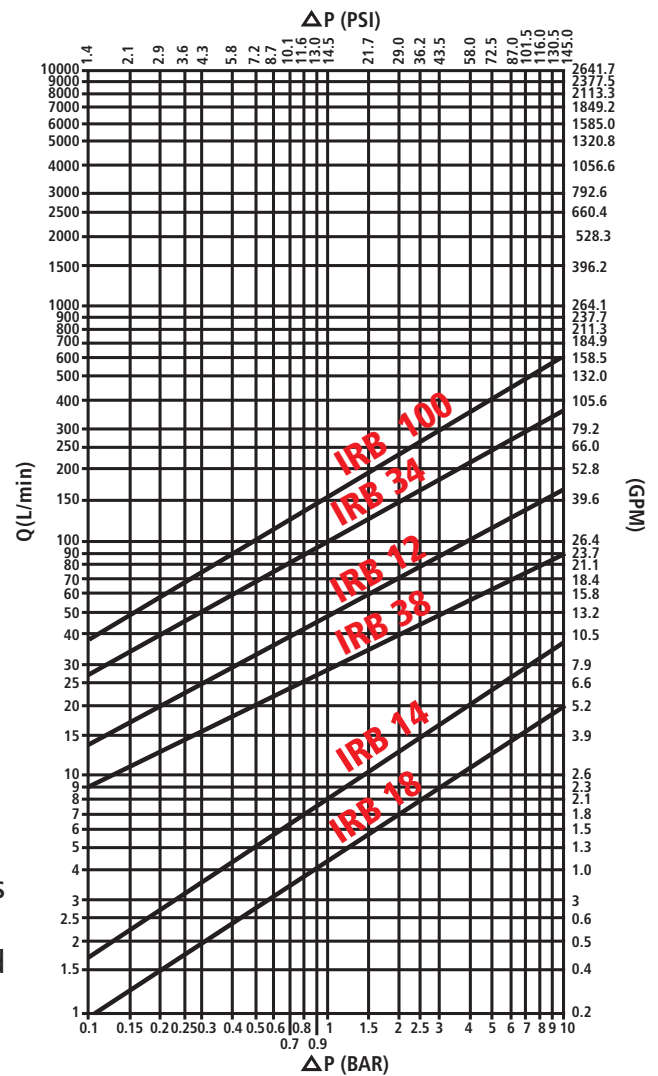

ISO B Interchange



Coupler



Nipple

Interchange: Parker 60 Series, Aeroquip FD45 Series: IRB -Steel

Part	Body Size	Port Size	Thread Type	Order Code	Part Description
Coupler	1/8	1/8	NPT	800601000	F. IRB 18 NPT
Nipple	1/8	1/8	NPT	800601001	M.IRB18 NPT
Coupler	1/4	1/4	NPT	800601002	F. IRB14 NPT
Nipple	1/4	1/4	NPT	800601003	M.IRB14 NPT
Coupler	3/8	3/8	NPT	800601004	F. IRB38 NPT
Nipple	3/8	3/8	NPT	800601005	M.IRB38 NPT
Coupler	1/2	1/2	NPT	800601006	F. IRB12 NPT
Nipple	1/2	1/2	NPT	800601007	M.IRB12 NPT
Coupler	3/4	3/4	NPT	800601008	F. IRB34 NPT
Nipple	3/4	3/4	NPT	800601009	M.IRB34 NPT
Coupler	1	1	NPT	800601010	F.IRB100 NPT
Nipple	1	1	NPT	800601011	M.IRB100 NPT
Coupler	1/4	3/8	SAE	800604202	F.IRBS 14E 3/8 SAE
Nipple	1/4	3/8	SAE	800604201	M.IRB 14E 3/8 SAE



Coupler



Nipple

Interchange: Parker 60 Series, Aeroquip FD45 Series: IRB -Brass

Part	Body Size	Port Size	Thread Type	Order Code	Part Description
Coupler	1/8	1/8	NPT	804501100	F. IRBOV 18 NPT
Nipple	1/8	1/8	NPT	804501101	M. IRBOV 18 NPT
Coupler	1/4	1/4	NPT	804501102	F. IRBOV 14 NPT
Nipple	1/4	1/4	NPT	804501103	M. IRBOV 14 NPT
Coupler	3/8	3/8	NPT	804501104	F. IRBOV 38 NPT
Nipple	3/8	3/8	NPT	804501105	M. IRBOV 38 NPT
Coupler	1/2	1/2	NPT	804501106	F. IRBOV 12 NPT
Nipple	1/2	1/2	NPT	804501107	M. IRBOV 12 NPT
Coupler	3/4	3/4	NPT	804501108	F. IRBOV 34 NPT
Nipple	3/4	3/4	NPT	804501109	M. IRBOV 34 NPT
Coupler	1	1	NPT	804501110	F. IRBOV 100 NPT
Nipple	1	1	NPT	804501111	M. IRBOV 100 NPT



Stucchi

Call us at 847-956-9720, Fax at 847-956-9723, or visit us on the web www.stucchiusa.com

Interchange: Parker 60 Series, Aeroquip FD45 Series: IRB -Stainless

Part	Body Size	Port Size	Thread Type	Order Code	Part Description
Coupler	1/8	1/8	NPT	804601100	F. IRBX 18 NPT
Nipple	1/8	1/8	NPT	804601101	M.IRBX 18 NPT
Coupler	1/4	1/4	NPT	804601102	F. IRBX 14 NPT
Nipple	1/4	1/4	NPT	804601103	M.IRBX 14 NPT
Coupler	3/8	3/8	NPT	804601104	F. IRBX 38 NPT
Nipple	3/8	3/8	NPT	804601105	M.IRBX 38 NPT
Coupler	1/2	1/2	NPT	804601106	F. IRBX 12 NPT
Nipple	1/2	1/2	NPT	804601107	M.IRBX 12 NPT
Coupler	3/4	3/4	NPT	804601108	F. IRBX34 NPT
Nipple	3/4	3/4	NPT	804601109	M.IRBX34 NPT
Coupler	1	1	NPT	804601110	F. IRBX100 NPT
Nipple	1	1	NPT	804601111	M.IRBX100 NPT

*Without valve available upon request



Coupler



Nipple

Item	Body Size	Size (MM)	A inch	B (mm)	C (mm)	D (mm)	E (mm)	F (mm)	I (mm)
IRB 18	1/8	5	1/8	48.8	23	30	60.5	15.8	15.8
IRB 14	1/4	6.3	1/4	57	27	35	70.7	20.8	21.2
IRB 38	3/8	10	3/8	66	34	41	82.7	26	27
IRB 12	1/2	12.5	1/2	73.9	42	46	92.6	29	29
IRB 34	3/4	20	3/4	90.1	50	55	111.1	38.5	38.5
IRB 100	1	25	1	106.2	60	66	133.2	44.8	44.6

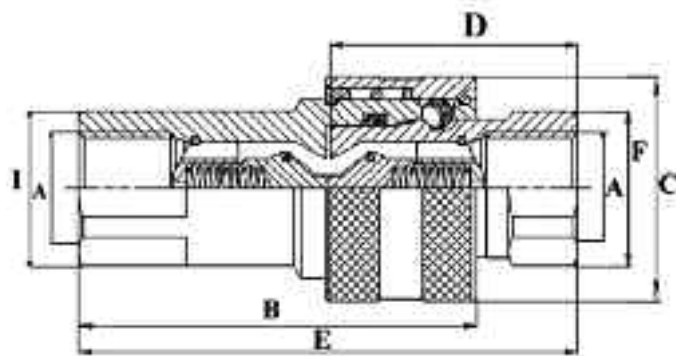

Agriculture Interchange Couplings



Overview:

Stucchi Agriculture Series are offered with a choice of either ball or poppet valve mechanisms for automatic shut-off during disconnection. The ball mechanism is the IR series, the poppet mechanism is the IR V series. The IR series are mainly for applications where interchangeability with existing equipment is necessary. For new applications poppet valves or flat-face are recommended.

Technical Characteristics and Options

- Coupling constructed in carbon steel with zinc plating
- Nipple made with hardened steel
- Standard seals are Nitrile
- NPT standard threads
- On request SAE, BSP threads
- Anti dust plastic caps
- Clip provided Nylon caps for IR12 female part

Series: IR IR/V

Interchange: Agriculture / ISO 5675

The series "IR" "IR/V" hydraulic quick couplings equipped with ball or poppet sealing valve are mostly applied in agricultural equipment; interchangeable according to **ISO 5675**. Size 12.5 is in accordance with ISO 7241-1 series "A".

Interchange: Parker 4000/8000, Faster NS/NV

- **IR** – Ball seal valve
- **IR/V** – Poppet seal valve
- **IRS** – Push-Pull coupling
- **IRS PC**– Push Pull sleeve-connectable under residual pressure.

Body Size	ISO Size	MAX Operating Pressure Coupled bar	MAX Operating Pressure Coupled PSI
Inch	MM		
1/4	6.3	300	4285
3/8	10.0	300	4285
1/2	12.5	250	3571
3/4	16.0	250	3571
1	19.0	200	2857



Stucchi

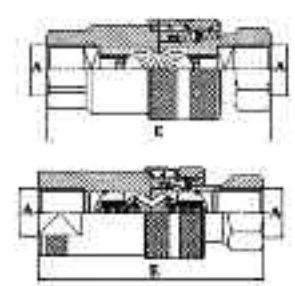
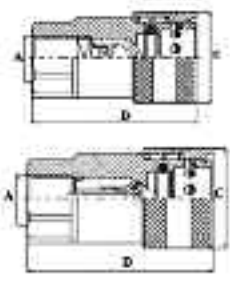
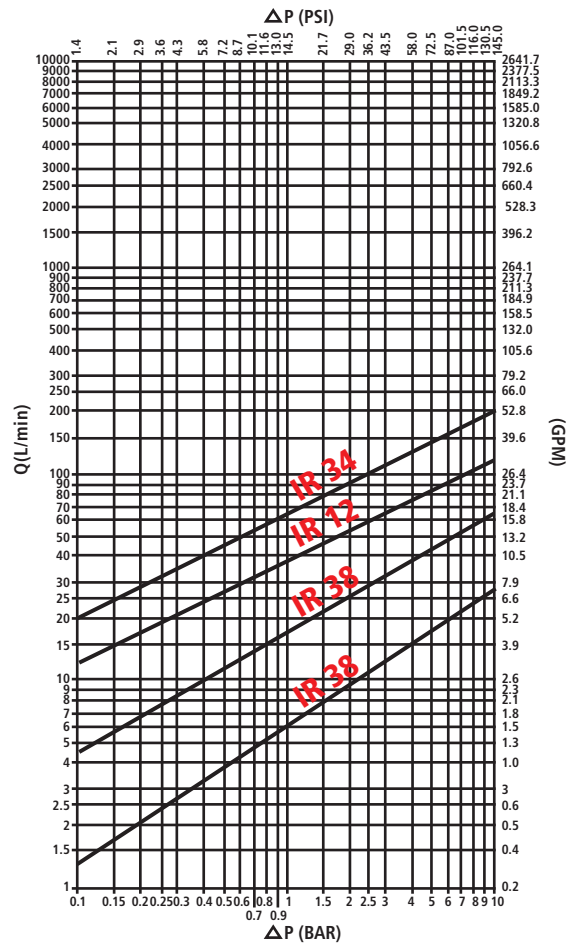
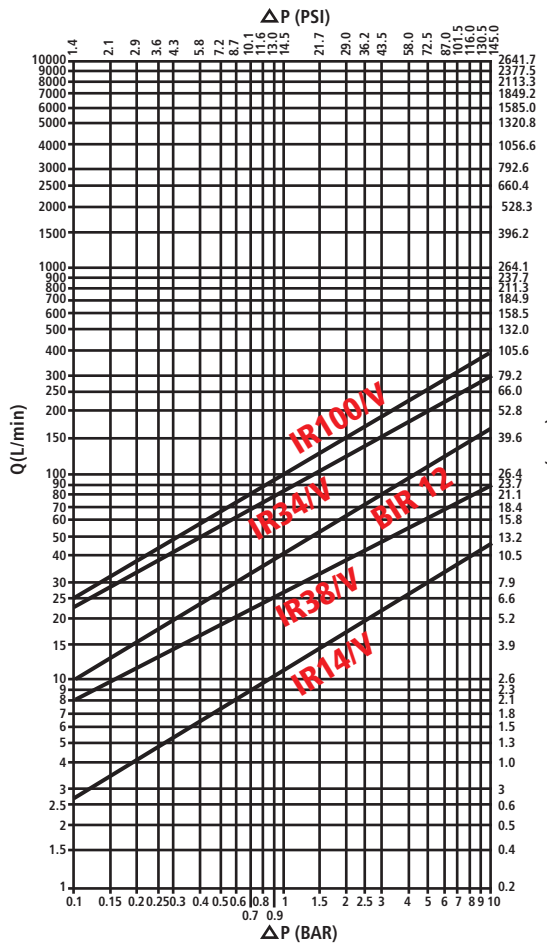

Item	Body Size	Size (MM)	A inch	B (mm)	C (mm)	D (mm)	E (mm)
IR 14	1/4"	6.3	1/4"	32.5	27	48.9	64.4
IR14V	1/4"	6.3	1/4"	32.5	27	50.4	65.9
IR 38	3/8"	10	3/8"	38	34	58.3	76.3
IR 38V	3/8"	10	3/8"	38	34	58.3	76.3
IR 12	1/2"	12.5	1/2"	44.5	38	63.3	86.3
BIR 12	1/2"	12.5	1/2"	44.5	38	63.3	86.3
IR 34	3/4"	16	3/4"	59	48	90.3	118.3
IR 34V	3/4"	16	3/4"	59	46	90.3	118.3
IR 100	1"	19	1"	66.1	54	99.6	132.8
IR 100V	1"	19	1"	64.1	54	97.6	128.8

Agriculture Interchange Couplings



Coupler



Nipple



Coupler

Interchange: Parker 4000, Faster NVSeries: IRV -Poppet Valve

Part	Body Size	Port Size	Thread Type	Order Code	Part Description
Coupler	1/4	1/4	NPT	800101000	F. IR14V NPT
Nipple	1/4	1/4	NPT	800101001	M. IR14V NPT
Coupler	3/8	3/8	NPT	800101002	F. IR38V NPT
Nipple	3/8	3/8	NPT	800101003	M. IR38V NP
Coupler	1/2	1/2	NPT	800501004	F. BIR 12 NPT
Nipple	1/2	1/2	NPT	800501005	M. BIR12 NPT
Coupler	3/4	3/4	NPT	800101004	F. IR34V NPT
Nipple	3/4	3/4	NPT	800101005	M. IR34V NPT
Coupler	1	1	NPT	800101006	F. IR100V NPT
Nipple	1	1	NPT	800101007	M. IR100V NPT
Coupler	3/4	3/4	NPT	820001022	F. IR34V FA NPT*
Nipple	3/4	3/4	NPT	820001023	M. IR34V FA NPT*
Coupler	1/4	3/8	SAE	800104000	F. IR 14V 38 SAE
Nipple	1/4	3/8	SAE	800104001	M. IR 14V 38 SAE

*Faster Interchange Only

Agricultural - Push/Pull Sleeve Series: IRS V -Poppet Valve

Part	Body Size	Port Size	Thread Type	Order Code	Part Description
Coupler	1/2	1/2	NPT	800401002	F. IRS12VA NPT

Agricultural - Push/Pull Sleeve / Connect under pressure Series: IRS PC – Poppet Style

Part	Body Size	Port Size	Thread Type	Order Code	Part Description
Coupler	1/2	1/2	NPT	800401004	F. IRS12VA PC NPT



Stucchi

Call us at 847-956-9720, Fax at 847-956-9723, or visit us on the web www.stucchiusa.com

Interchange: Parker 4000, Faster NS Series: IR -Ball Valve

Part	Body Size	Port Size	Thread Type	Order Code	Part Description
Coupler	1/4	1/4	NPT	800001000	F. IR 14 NPT
Nipple	1/4	1/4	NPT	800001001	M.IR14 NPT
Coupler	3/8	3/8	NPT	800001002	F. IR38 NPT
Nipple	3/8	3/8	NPT	800001003	M.IR38 NPT
Coupler	1/2	1/2	NPT	800001004	F. IR 12 NPT
Nipple	1/2	1/2	NPT	800001005	M.IR 12 NPT
Coupler	3/4	3/4	NPT	800001006	F. IR 34 NPT
Nipple	3/4	3/4	NPT	800001007	M.IR 34 NPT
Coupler	1	1	NPT	800001008	F. IR 100 NPT
Nipple	1	1	NPT	800001009	M.IR 100 NPT
Coupler	3/4	3/4	NPT	820001020	F. IR34 FA NPT*
Nipple	3/4	3/4	NPT	820001021	M.IR34 FA NPT*

*Faster Interchange Only

Coupler



Nipple

Agricultural –Nipple w/ seal retainer Series: IR –"TIC" –ball valve

Part	Body Size	Port Size	Thread Type	Order Code	Part Description
Nipple	1/2	1/2	NPT	800001011	M. IR12 TIC NPT

Push/Pull Sleeve Ag Interchange Series: IRS -Ball Style

Part	Body Size	Port Size	Thread Type	Order Code	Part Description
Coupler	1/2	1/2	NPT	800301002	F. IRS12A NPT

*Push Pull Sleeve



Coupler

Wingstyle Interchange Couplings



Series: W
Interchange: Parker 6100, Aeroquip 5100
Rugged Wing Nut provides reliable service

- Seals: Nitrile
- Threaded sleeve allows connection / disconnection under pressure
- Coupler: Brass Material
- Wing: Cast steel
- Nipple: Brass Material

Nominal Size Inch	RATED FLOW@ 50 psi Press. Drop GPM	Burst Pressure PSI	MAX Working Pressure bar	MAX Working Pressure PSI
3/4	35	9000	207	3000
1	55	9000	207	3000
1 ¼	80	8250	190	2750
1 ½	110	7500	172	2500

Series: W – Thread to connect



Part	Body Size	Port Size	Thread Type	Order Code	Part Description
Coupler	3/4	3/4	NPT	100610012	F. W6F6-B
Nipple	3/4	3/4	NPT	100610112	M. W6F6-B
Coupler	1	1	NPT	100610016	F. W8F8-B
Nipple	1	1	NPT	100610116	M. W8F8-B
Coupler	1 ¼	1 ¼	NPT	100610020	F. W10F10-B
Nipple	1 ¼	1 ¼	NPT	100610120	M. W10F10-B
Coupler	1 ½	1 ½	NPT	100610024	F. W12F12-B
Nipple	1 ½	1 ½	NPT	100610124	M. W12F12-B

W Series – Brass Caps

Prices available upon request

Code	Description	Cap for Coupler
200610012	F.CAP 6WDP-B	100610012
200610112	M.CAP W6DC-B	100610112
200610016	F.CAP 8WDP-B	100610016
200610116	M.CAP W8DP-B	100610116
200610020	F.CAP 10WDP-B	100610020
200610120	M.CAP W10DC-B	100610120
200610024	F.CAP 12WDP-B	100610024
200610124	M.CAP W12DC-B	100610124



Call us at 847-956-9720, Fax at 847-956-9723, or visit us on the web www.stucchiusa.com

Enerpac Interchange Couplings



Series: IVHP

Interchange: Enerpac / Hydraulic Jack

Interchange: Parker 3000

- 10,000 PSI Working Pressure
- Seals: Nitrile
- Material: Hardened steel for higher burst pressure than competitors
- Threaded sleeve allows connection / disconnection under pressure
- Interchange with Parker 3000

Stucchi Series	Nominal Size Inches	ISO Size MM	MAX OPERATING PRESSURE COUPLED bar	MAX OPERATING PRESSURE COUPLED PSI	Burst Pressure Coupled Bar	Burst Pressure Coupled PSI
IVHP 1/4	1/4	6.3	700	10,000	2500	35,714
IVHP 3/8	3/8	10.0	700	10,000	2350	33,571

Thread to Connect –High Pressure Interchange: Enerpac Series: IVHP -10,000 psi

Part	Body Size	Port Size	Thread Type	Order Code	Part Description
Coupler	1/4	1/4	NPT Male	800201008	F. IVHP 1/4 NPT EXT
Nipple	1/4	1/4	NPT Female	800201009	M.IVHP 1/4 NPT
Coupler	3/8	3/8	NPT Male	800201004	F. IVHP 3/8 NPT EXT
Nipple	3/8	3/8	NPT Female	800201005	M.IVHP 3/8 NPT
Coupler	3/8	3/8	NPT Female	800201014	F. IVHP 3/8 NPT

*Yellow Zinc Plating Available Upon Request



IVHP SERIES – Metal Caps

Code	Description
815605002	CAP F. IV38HP
815605003	CAP M. IV38HP
815605004	CAP F. IV14HP
815605005	CAP M.IV14HP



Adapter Couplers Flat Face/ISO A



Series: F.FIRG12A M.BIR12 M.FIRG12A F.BIR12

Advantages of Adapters

- Provides compatibility between old and new equipment
- Avoids changing mismatched couplers
- Bi-Directional Flow

Stucchi Series	Nominal Size	ISO Size	MAX OPERATING PRESSURE COUPLED bar	MAX OPERATING PRESSURE COUPLED PSI
VEP	Inches	MM		
F.FIRG12A M.BIR12	1/2	12.5	250	3750
M.FIRG12A F.BIR12	1/2	12.5	250	3750

Adapter Couplers – Flat-Face / ISO A Series: 8036- Adapter

Description	Order Code	Part Inscription
1/2" Female Flat Face / 1/2" Male ISO A	803622000	F.FIRG12A M.BIR12
1/2" Male Flat Face / 1/2" Female ISO A	803622001	M.FIRG12A F.BIR12



F.FIRG12A M.BIR12



M.FIRG12A F.BIR12



Series: IV
Interchange: Stucchi Only



Series: IV
Interchange: Stucchi Only

Series IV is a screw to connect coupling range available in sizes from 1/4" to 2 inch. This series is used in heavy duty hydraulic and industrial applications in the presence of high pressure, vibrations, and mechanical stresses.

- Standard material: steel
- Internal valves in hardened steel
- Standard seals in nitril rubber
- Back-up seals in Teflon
- Working temperature with standard seals: -20C / +110C

Interchange: Stucchi Only Threaded Poppet Couplings: IV Series

Part	Body Size	Port Size	Thread Type	Order Code	Part Description
Coupler	1/4	1/4	BSP	820100000	F. IV 14 BSP
Nipple	1/4	1/4	BSP	820100001	M. IV 14 BSP
Coupler	3/8	3/8	BSP	820100002	F. IV 38 BSP
Nipple	3/8	3/8	BSP	820100003	M. IV 38 BSP
Coupler	1/2	1/2	BSP	820100004	F. IV 12 BSP
Nipple	1/2	1/2	BSP	820100005	M. IV 12 BSP
Coupler	3/4	3/4	BSP	820100006	F. IV 34 BSP
Nipple	3/4	3/4	BSP	820100007	M. IV 34 BSP
Coupler	1	1	BSP	820100008	F. IV 100 BSP
Nipple	1	1	BSP	820100009	M. IV 100 BSP
Coupler	1 1/4	1 1/4	BSP	820100010	F. IV 114 BSP
Nipple	1 1/4	1 1/4	BSP	820100011	M. IV 114 BSP
Coupler	1 1/2	1 1/2	BSP	820100012	F. IV 112 BSP
Nipple	1 1/2	1 1/2	BSP	820100013	M. IV 112 BSP
Coupler	2	2	BSP	820100014	F. IV 200 BSP
Nipple	2	2	BSP	820100015	M. IV 200 BSP



Prices available upon request

Check Valves



Overview:

- VU series are used in any type of hydraulic circuit.
- Alternative uses: as pressure sequence valve by adjusting the internal spring loading to the required "cracking point", according to the valve size

Instructions for use

- The VU series must be assembled in the circuit so that the direction of the flow corresponds to the direction of the arrow marked on the valve.

Series: VU

The Stucchi check valve design is safe, compact, suitable to any hydraulic application using non-corrosive liquids. The VU size-range includes two different standard openings at 5 to 65 PSI.

- Material: Steel with black phosphate
- Closing spring in C72 material
- Standard Crack 5psi & 65 psi
- Standard SAE and NPT threads
- Various crack pressures optional
- Central exhausting hole option
- Zinc plating available upon request

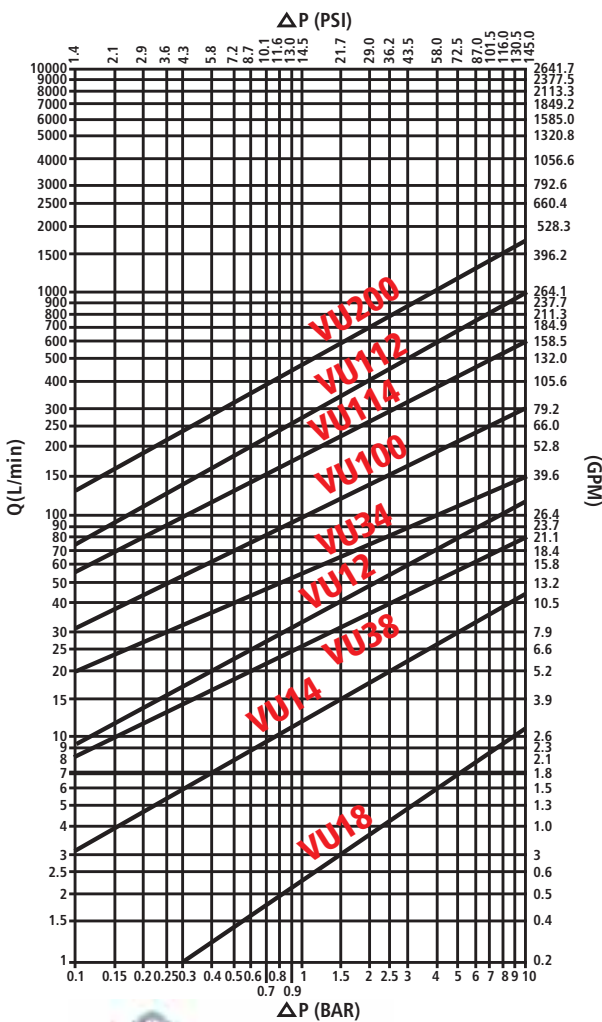

STUCCHI SERIES VU	NOMINAL SIZE INCH	ISO SIZE MM	MAX OPERATING PRESSURE bar	MAX OPERATING PRESSURE psi
VU18	1/8	5.0	400	5714
VU14	1/4	6.3	350	5000
VU38	3/8	10.0	350	5000
VU12	1/2	12.5	300	4285
VU34	3/4	16.0	300	4285
VU100	1	19.0	300	4285
VU114	1 ¼	25.0	250	3571
VU112	1 ½	31.5	250	3571
VU200	2	40.0	150	2100



Series VU – Check Valves NPT Thread

Crack Point	Body Size	Port Size	Thread Type	Order Code: Black Oxide	Order Code: Yellow Zinc	Part Description
5 psi	1/8	1/8	NPT	810201100	810501100	VU 18 NPT 5 PSI
5 psi	1/4	1/4	NPT	810201101	810501101	VU 14 NPT 5 PSI
5 psi	3/8	3/8	NPT	810201102	810501102	VU 38 NPT 5 PSI
5 psi	1/2	1/2	NPT	810201103	810501103	VU 12 NPT 5 PSI
5 psi	3/4	3/4	NPT	810201104	810501104	VU 34 NPT 5 PSI
5 psi	1	1	NPT	810201105	810501105	VU 100 NPT 5 PSI
5 psi	1 ¼	1 ¼	NPT	810201106	810501106	VU 114 NPT 5 PSI
5 psi	1 ½	1 ½	NPT	810201107	810501107	VU 112 NPT 5 PSI
5 psi	2	2	NPT	810201108	810501108	VU 200 NPT 5 PSI
5 psi	3/4	3/4	NPT	810201109	810501109*	VU 34F 1.5 NPT 5 PSI
5 psi	1	1	NPT	810201110	810501110*	VU 100F 1.5 NPT 5 PSI
5 psi	1/2	1/2	NPT	810201112	810501112*	VU 12EI NPT 5 PSI**

*Available upon special request. **Female x Male NPT



Series VU – Check Valves NPT Thread

Crack Point	Body Size	Port Size	Thread Type	Order Code: Black Oxide	Order Code: Yellow Zinc	Part Description
65 psi	1/8	1/8	NPT	810201400	810501400	VU 18 NPT 65 PSI
65 psi	1/4	1/4	NPT	810201401	810501401	VU 14 NPT 65 PSI
65 psi	3/8	3/8	NPT	810201402	810501402	VU 38 NPT 65 PSI
65 psi	1/2	1/2	NPT	810201403	810501403	VU 12 NPT 65 PSI
65 psi	3/4	3/4	NPT	810201404	810501404	VU 34 NPT 65 PSI
65 psi	1	1	NPT	810201405	810501405	VU 100 NPT 65 PSI
65 psi	1 ¼	1 ¼	NPT	810201406	810501406	VU 114 NPT 65 PSI
65 psi	1 ½	1 ½	NPT	810201407	810501407	VU 112 NPT 65 PSI
65 psi	2	2	NPT	810201408	810501408	VU 200 NPT 65 PSI



Series VU – Check Valves SAE Thread

Crack Point	Body Size	Port Size	Thread Type	Order Code: Black Oxide	Order Code: Yellow Zinc	Part Description
5 psi	1/4	1/4	SAE	810204100	810504100	VU 14 SAE 5 PSI
5 psi	3/8	3/8	SAE	810204101	810504101	VU 38 SAE 5 PSI
5 psi	1/2	1/2	SAE	810204102	810504102	VU 12 SAE 5 PSI
5 psi	3/4	3/4	SAE	810204103	810504103	VU 34 SAE 5 PSI
5 psi	1	1	SAE	810204104	810504104	VU 100 SAE 5 PSI
5 psi	1 ¼	1 ¼	SAE	810204105	810504105	VU 114 SAE 5 PSI
5 psi	1 ½	1 ½	SAE	810204106	810504106	VU 112 SAE 5 PSI
5 psi	2	2	SAE	810204107	810504107	VU 200 SAE 5 PSI



Check Valves

Series VU – Check Valves SAE Thread



Crack Point	Body Size	Port Size	Thread Type	Order Code: Black Oxide	Order Code: Yellow Zinc	Part Description
65 psi	1/4	1/4	SAE	810204400	810504404	VU 14 SAE 65 PSI
65 psi	3/8	3/8	SAE	810204401	810504401	VU 38 SAE 65 PSI
65 psi	1/2	1/2	SAE	810204402	810504402	VU 12 SAE 65 PSI
65 psi	3/4	3/4	SAE	810204403	810504403	VU 34 SAE 65 PSI
65 psi	1	1	SAE	810204404	810504400	VU 100 SAE 65 PSI
65 psi	1 ¼	1 ¼	SAE	810204405	810504405	VU 114 SAE 65 PSI
65 psi	1 ½	1 ½	SAE	810204406	810504406	VU 112 SAE 65 PSI
65 psi	2	2	SAE	810204407	810504407	VU 200 SAE 65 PSI

Series: VU – Check Valves NPT Thread



Crack Point	Body Size	Port Size	Thread Type	Order Code:	Part Description
14 psi	1/4	1/4	NPT	810201200	VU 14 NPT 14 PSI
14 psi	1/2	1/2	NPT	810201201	VU 12 NPT 14 PSI
14 psi	3/4	3/4	NPT	810201202	VU 34 NPT 14 PSI
14 psi	1	1	NPT	810201203	VU 100 NPT 14 PSI
14 psi	1 ¼	1 ¼	NPT	810201204	VU 114 NPT 14 PSI
14 psi	1 ½	1 ½	NPT	810201205	VU 112 NPT 14 PSI
21 psi	1	1	NPT	810201300	VU 100 NPT 21 PSI
57 psi	1/2	1/2	NPT	810201409	VU 12 NPT 57 PSI
115 psi	1/2	1/2	NPT	810201600	VU 12 NPT 115 PSI
115 psi	3/4	3/4	NPT	810201601	VU 34 NPT 115 PSI
145 psi	1	1	NPT	810201602	VU 100 NPT 145 PSI
215 psi	1/4	1/4	NPT	810201700	VU 14 NPT 215 PSI
290 psi	1/2	1/2	NPT	810201701	VU 12 NPT 290 PSI

DIMENSIONS

Item	Body Size	Size (MM)	A inch	B (mm)
VU 18	1/8"	5	1/8"	44
VU 14	1/4"	6.3	1/4"	60
VU 38	3/8"	10	3/8"	70
VU 12	1/2"	12.5	1/2"	77
VU 34	3/4"	16	3/4"	90
VU 100	1"	19	1"	106
VU 114	1 ¼"	25	1 ¼"	125
VU 112	1 ½"	31.5	1 ½"	140
VU 200	2"	40	2"	160

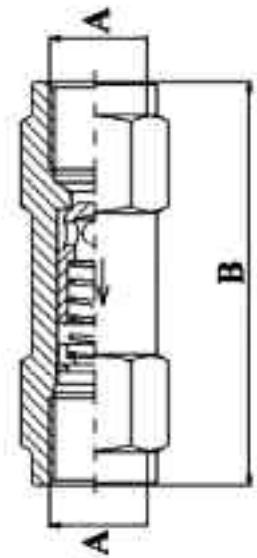

Multi-Coupling Plates: MP Series Hydraulic



Applications

- Front end loaders
- Harvesting Equipment
- Construction Machinery
- Refrigeration
- Snow Removal Equipment
- Any application requiring connection under residual pressure of multiple couplings

Features

- Connect up to 300 bar residual pressure
- Auto safety lock when connected
- Single hand operation
- Compact design

Series: MULTICOUPLING PLATE

General data:

The Multicoupling Plate is a tool allowing the simultaneous couple and uncouple of a certain number of hydraulic and/or electrical lines. From a minimum of two to a maximum of ten lines can be simultaneously connected by a single, simple movement requiring very little force. The energy lines can all have the same nominal diameter or each line can be different from the others according to the application. A special multicoupling plate version provided with electrical connector can be supplied.

- Connects with residual pressure
- Mechanical connection eliminates brinelling effect
- Safe lock prevents unwanted disconnection
- Simple to use with a single movement applied by one arm only
- Ease of maintenance or replacement of quick couplings
- Cap & Parking station available

Multi-Coupling Plates: MP Series Hydraulic

Technical Characteristics & Instructions for Use

The connection is done by inserting the mobile part locator pins in the fixed part holes. The position of the locking lever is put in the connection position (at 11 by the clock). Now the mobile part "falls" towards the fixed part and the pins place themselves in the connection position. Quick coupling faces are in line, but not yet coupled; they are now guided but not yet engaged.

Pull Red safety lock and then easily turn the lever till 9 o'clock, with a small connection force. Valving design allows for connection under any residual pressure in the hose lines.

During the final movement of the handle between 7 & 8 o'clock some resistance is felt. A mechanical click indicates full engagement and is auto-locked at end of stroke. To uncouple push the red button and turn the locking lever upwards clockwise. The highest disconnection force is found between 8 and 9 by the clock.

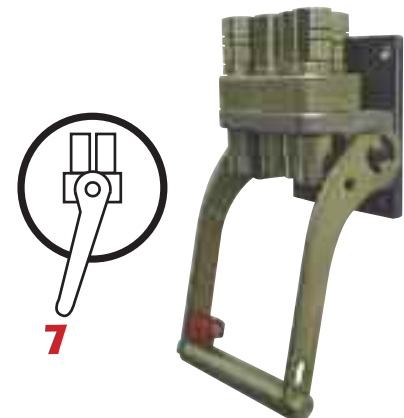
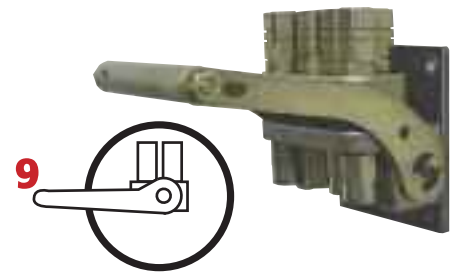
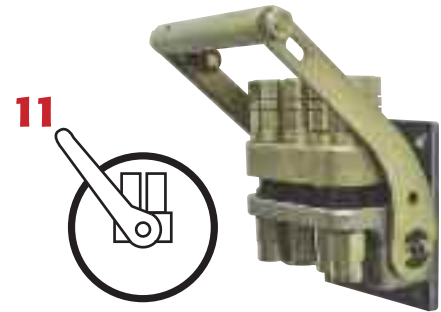

Stucchi USA Inc. offers both standard stock Multicoupling Plates along with engineered solutions to your application. Please contact a Stucchi representative to find the best solution for your application.



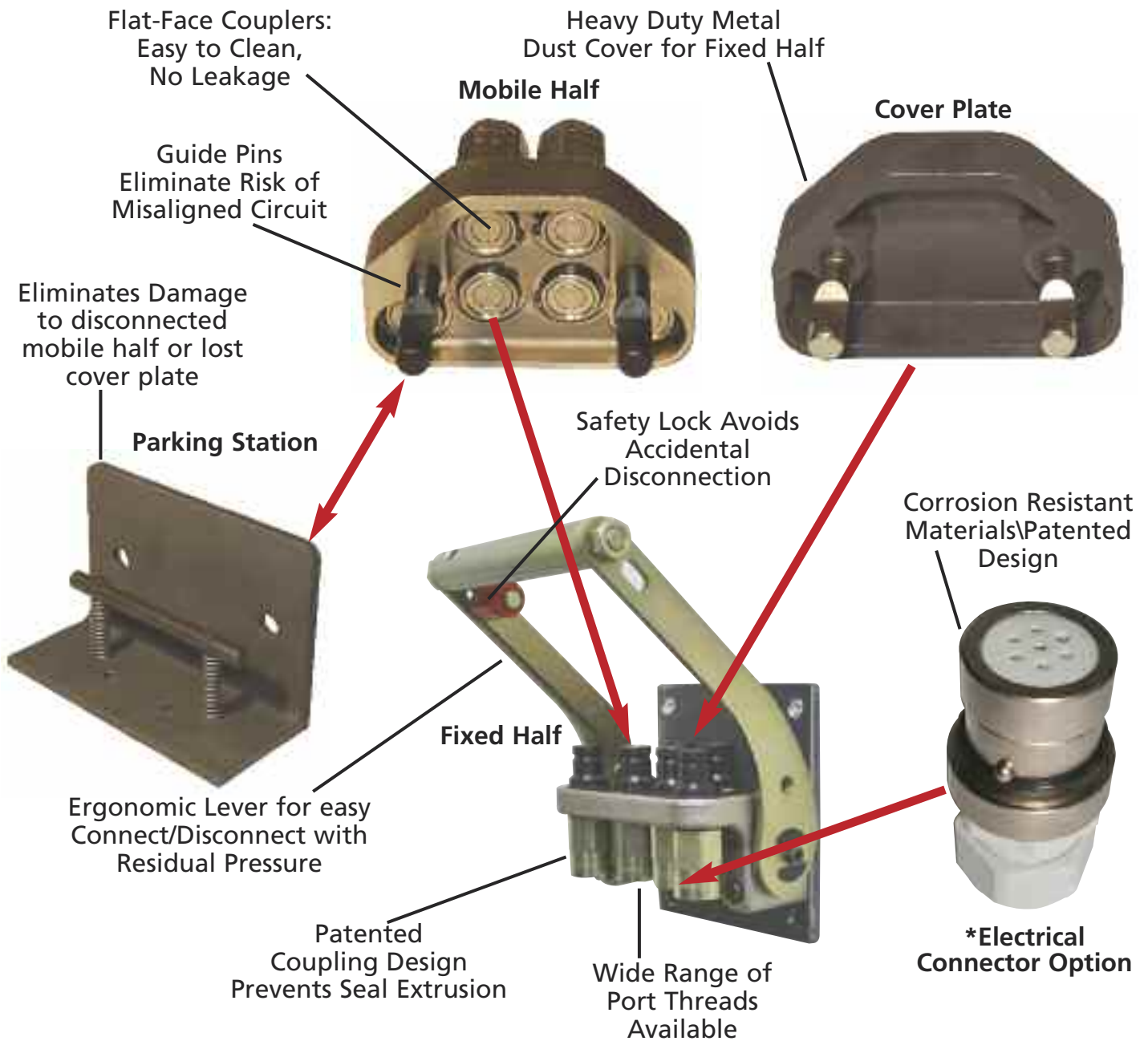

The Stucchi Solution to Connecting Multiple Couplings Simultaneously

1. Ergonomic Lever for Easy Connect/Disconnect with Residual Pressure
2. Patented Coupling Design to Connect/Disconnect Multiple Couplings with High Residual Pressure
3. Flat-Face Couplers Eliminate Environmental Issue of Leakage
4. No Risk of Misalignment with Guide Pin Design
5. Couplers Mounted with Snap Rings for Ease of Installation or Replacement
6. Fixed Half Male Couplers Interchangeable with ISO 16028 Style Flat-Face Coupling
7. Electrical Connector option for electronic control systems
8. Easily Mounted on New Equipment or Retrofit on Pre-existing System

Multi-Coupling Plates: Hydraulic Couplers-Same Size

Order Code Structure

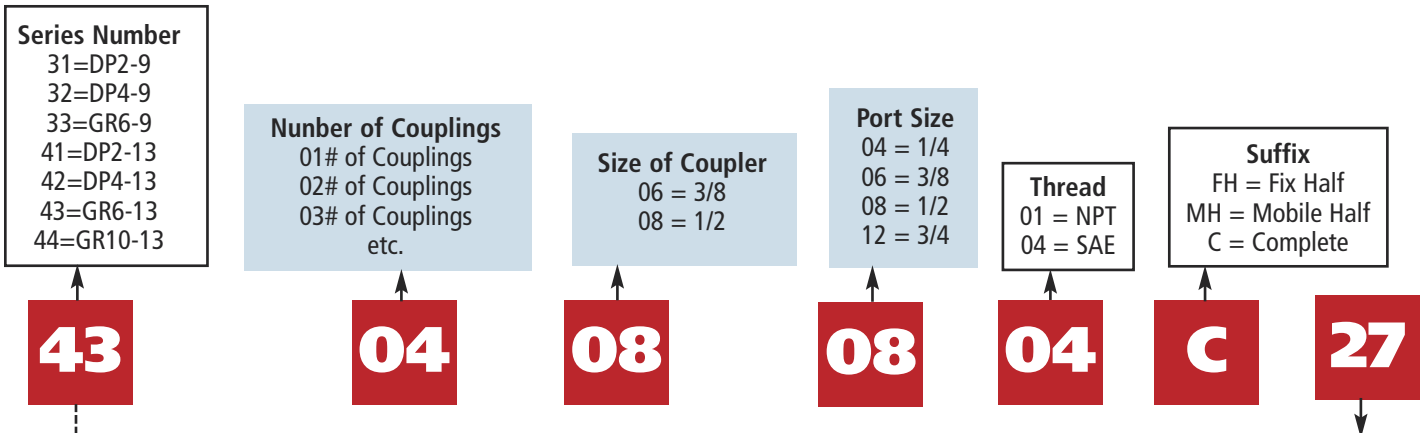

Mult-Coupler Plates Capacity Chart

Series Order Code Prefix	Coupler body size & Code No. → Multi-Coupler Plate Series Same size Couplers	No. FAP9 (3/8")	No. FAP13 (1/2")
31	DP2-9	2	0
41	DP2-13	0	2
32	DP4-9	4	0
42	DP4-13	0	4
35	GR3-9	3	0
45	GR3-13	0	3
33	GR6-9	6	0
43	GR6-13	0	6
34	GR10-9	10	0
44	GR10-13	0	10

Suffix Option for electrical connection
Number of Electrical Connections
17 = 1 electrical connection 7 prongs
16 = 1 electrical connection 6 prongs
27 = 2 electrical connection 7 prongs

Notes:

Plate capacities listed are the maximum number of Couplers per Plate.
All Plates can be made with fewer Couplers.
Electrical Connectors can be added to many Plates using 1/2" Couplers.
Consult Stucchi USA for specific applications.

Common Stock Items

Stucchi Order	Code Description	Number of Couplers	Coupler Size	Port Size	Thread Type
3102060601C	DP2-9(2)NPT	2	3/8	3/8	NPT
3102060604C	DP2-9(2)SAE	2	3/8	3/8	SAE
3204060601C	DP4-9(4)NPT	4	3/8	3/8	NPT
3204060604C	DP4-9(4)SAE	4	3/8	3/8	SAE
3306060601C	GR6-9(6)NPT	6	3/8	3/8	NPT
3306060604C	GR6-9(6)SAE	6	3/8	3/8	SAE
4102080801C	DP2-13(2)NPT	2	1/2	1/2	NPT
4102080804FH	FH-DP2-13(2)SAE	2	1/2	1/2	SAE
4102080804MH	MH-DP2-13(2)SAE	2	1/2	1/2	SAE
4102080804C	DP2-13(2)SAE	2	1/2	1/2	SAE
4204080801C	DP4-13(4)NPT	4	1/2	1/2	NPT
4204080804C	DP4-13(4)SAE	4	1/2	1/2	SAE
4306080801C	GR6-13(6)NPT	6	1/2	1/2	NPT
4306080804C	GR6-13(6)SAE	6	1/2	1/2	SAE
4408080801FH	FH-GR10-13(8)NPT	8	1/2	1/2	NPT
4408080801MH	MH-GR10-13(8)NPT	8	1/2	1/2	NPT
4410080801C	GR10-13(10)NPT	10	1/2	1/2	NPT
4410080804C	GR10-13(10)SAE	10	1/2	1/2	SAE

The above list consists of the most popular stock items. Standard plates offer a variety of Hydraulic Coupler & Electrical Connector combinations too broad to list in this brochure. Use the Stucchi Ordering Code System to create a Coupling Plate configuration for your application or fill out & fax the custom plate form for non-standard configurations.



Pricing for plates available upon request

Multi-Coupling Plates: Multiple size couplings

Order Code Structure

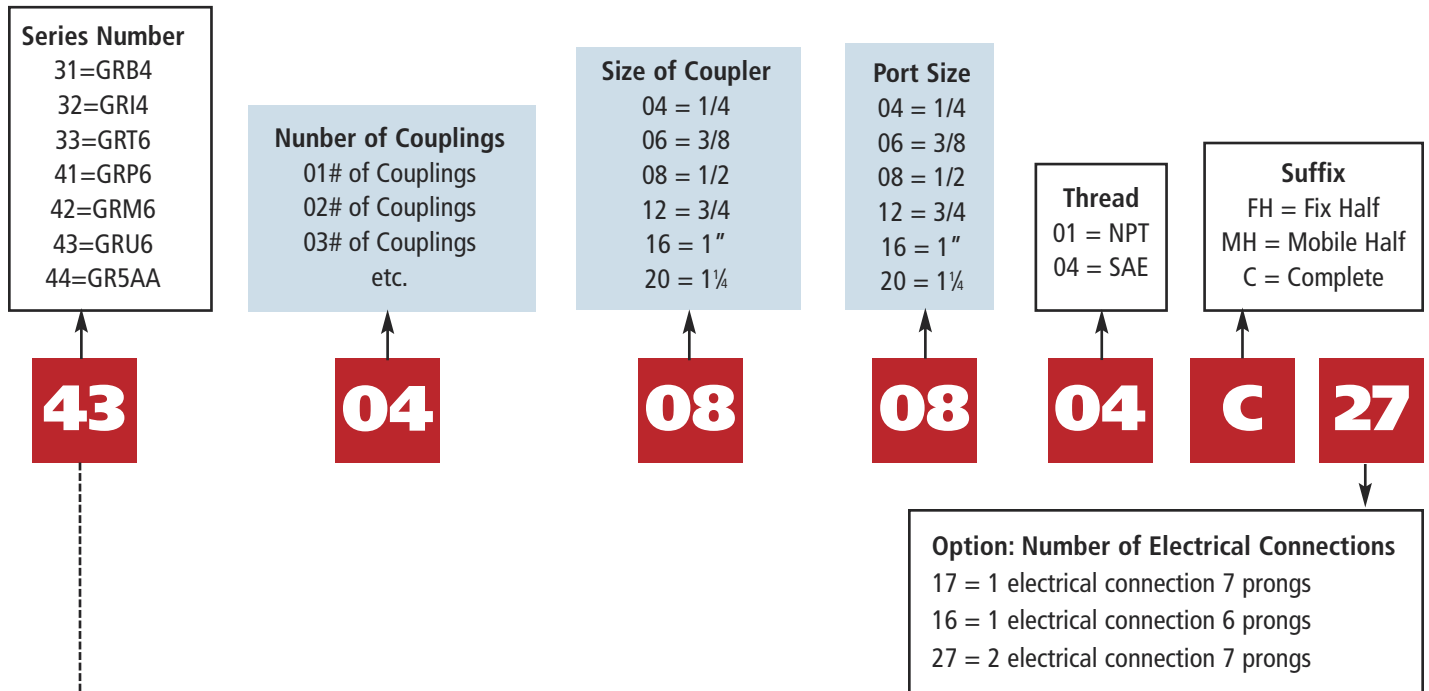

Multi-Coupler Plate Capacities

Series Order Code Prefix	Coupler Code# & Coupler Size → Multi-Coupler Plate Series Multiple size Couplers	FAP 9 3/8"	FAP 13 1/2"	FAP 15 3/4"	FAP 17 1"	FAP 21 1 1/4"
31	GRB4	2	2			
41	GRP6	1	1	1	2	
32	GRI4	2		1	1	
42	GRM6	2		2	2	
35	GRC6	3	1	1	1	
45	GRD5	3			1	1
33	GRT6	4	2			
43	GRU6	2	2		1	1
34	GRZ5		2	2		1
47	GR6AB		4		2	
51	GR5AA		2		3	
45	GRI4TB	2		2		
46	GRK3	1				2
48	GR6LL		2		4	
47	GRM6AL	2		4		
54	GRM6MC	2	2	2		
45	GRI4SB	2	1	1		

Notes:

Plate capacities listed are the maximum number of Couplers per Plate.
All Plates can be made with fewer Couplers.
Electrical Connectors can be added to any Plates using 3/8" or 1/2" port spaces.
Consult Stucchi USA for specific applications.

The above list consists of the most popular stock items. Standard plates offer a variety of Hydraulic Coupler & Electrical Connector combinations too broad to list in this brochure. Use the Stucchi Ordering Code System to create a Coupling Plate configuration for your application or fill out & fax the custom plate form for non-standard configurations.

Pricing for plates available upon request

Multi-Coupling Plates: Multiple size couplings

Replacement Couplers Series: FAP



Coupler



Nipple

Part	Body Size	Port Size	Thread Type	Order Code	Part Description
Coupler	3/8	1/2	NPT	805001050	F. FAP9PA 1/2 NPT
Nipple	3/8	1/2	NPT	805001051	M. FAP9PA 1/2 NPT
Coupler	3/8	3/8	NPT	805001052	F. FAP9PA 3/8 NPT
Nipple	3/8	3/8	NPT	805001053	M. FAP9PA 3/8 NPT
Coupler	3/8	3/8	NPT	805001074	F. FAP9PD 3/8 NPT
Nipple	3/8	3/8	NPT	805001075	M. FAP9PD 3/8 NPT
Coupler	3/8	1/2	NPT	805001076	F. FAP9PD 1/2 NPT
Nipple	3/8	1/2	NPT	805001077	M. FAP9PD 1/2 NPT
Coupler	3/8	1/2	SAE	805004020	F. FAP9PD 1/2 SAE
Nipple	3/8	1/2	SAE	805004021	M. FAP9PD 1/2 SAE
Coupler	3/8	1/2	SAE	805004012	F. FAP9PA 1/2 SAE
Nipple	3/8	1/2	SAE	805004013	M. FAP9PA 1/2 SAE
Coupler	1/2	1/2	NPT	805001056	F. FAP13P 1/2 NPT
Nipple	1/2	1/2	NPT	805001057	M. FAP13P 1/2 NPT
Coupler	1/2	3/4	NPT	805001058	F. FAP13P 3/4 NPT
Nipple	1/2	3/4	NPT	805001059	M. FAP13P 3/4 NPT
Coupler	1/2	1/2	SAE	805004004	F. FAP13P 1/2 SAE
Nipple	1/2	1/2	SAE	805004005	M. FAP13P 1/2 SAE
Coupler	1/2	3/4	SAE	805004058	F. FAP13P 3/4 SAE
Nipple	1/2	3/4	SAE	805004059	M. FAP13P 3/4 SAE
Coupler	1/2	5/8	SAE	805004005	F. FAP13P 5/8 SAE
Nipple	1/2	5/8	SAE	805004007	M. FAP13P 5/8 SAE
Coupler	3/4	3/4	NPT	805001078	F. FAP15P 3/4 NPT
Nipple	3/4	3/4	NPT	805001079	M. FAP15P 3/4 NPT
Coupler	3/4	3/4	SAE	805004078	F. FAP15P 3/4 SAE
Nipple	3/4	3/4	SAE	805004079	M. FAP15P 3/4 SAE
Coupler	1	1	NPT	805001082	F. FAP17P 1" NPT
Nipple	1	1	NPT	805001083	M. FAP17P 1" NPT
Coupler	1	1	SAE	805004082	F. FAP17P 1" SAE
Nipple	1	1	SAE	805004083	M. FAP17P 1" SAE
Coupler	1 1/4	1 1/4	NPT	805001084	F. FAP21P 114 NPT
Nipple	1 1/4	1 1/4	NPT	805001085	M. FAP21P 114 NPT
Coupler	1 1/4	1 1/4	SAE	805004084	F. FAP21P 114 SAE
Nipple	1 1/4	1 1/4	SAE	805004085	M. FAP21P 114 SAE

Parking Stations

Order Code	Description
815606009	PARKING STATION GR3-9
815606001	PARKING STATION GR6-9
815606003	PARKING STATION GR6-13
815606025	PARKING STATION GR10-13
815606029	PARKING STATION DP2-9
815606039	PARKING STATION DP4-9
815606037	PARKING STATION DP2-13
815606041	PARKING STATION DP4-13



Stucchi

Call us at 847-956-9720, Fax at 847-956-9723, or visit us on the web www.stucchiusa.com

Multi-Coupling Plates: GRE Series



Overview:

The Stucchi GRE Series of Multi-Coupling Plates is designed as a solution for industrial applications such as fast tool changes on injection molding & die cast equipment. Coupling plates reduce down-time between production runs wherever pneumatic, oil, water, and electrical circuits are to be connected to production machines or test benches, etc. This series is designed to meet the requirements of flexible manufacturing of present and future production machines and processes. The GRE series connects with little effort due to its superior guidance pin system. The GRE series only connects in one position, preventing any connection error by inversion of circuits.

Features & Options:

- Compact Aluminum manifold construction
- Port Options: Female thread, Hose barbs, 90 degree.
- Valve options: Single shut-off, Double shut-off, full flow.
- Snap-Ring mount allows easy installation & maintenance of couplers.
- Auto-Lock design prevents accidental disconnection
- Circuits: 6-12-18 positions

Series: GRE Series

General data:

The Multi-coupling Plate is a tool allowing the simultaneous couple and uncouple of a certain number of water, air, oil and/or electrical lines. From a minimum of 6 to a maximum of 18 lines can be simultaneously connected by a single, simple movement requiring very little effort. The energy lines can all have the same nominal diameter with different media according to the application. Offered coupler sizes: 3/8 & 1/2 with various ports, low pressure applications

- Connects w/ residual pressure: 2-3 bar
- Safe lock prevents unwanted disconnection
- Simple to use with a single movement applied by one arm only
- Ease of maintenance or replacement of quick couplings.

**Instructions for Use
Plate before Connecting:**

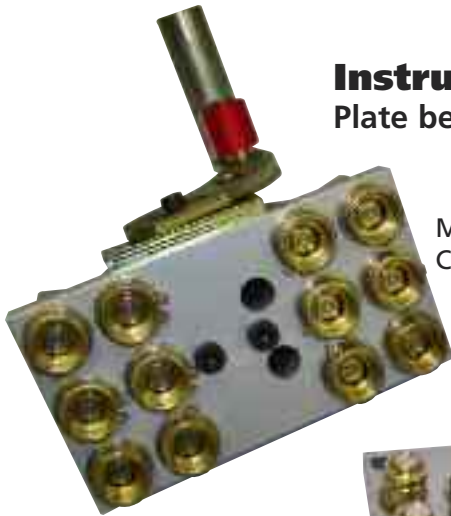

Mobile Half: Female Couplers w/ locking handle

Fixed Half: Guide pins with male couplers



Connecting Plate:

1. Align guide pins on Fixed Half with mating port of Mobile Half

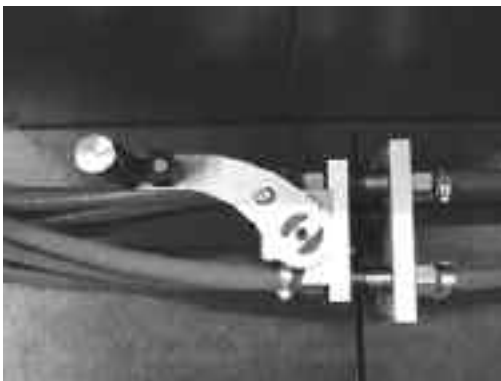

2. Insert Guide pins into the mating ports. At this moment the weight of the hoses & side loads are supported by the guide pins. This is the 11 o'clock position..

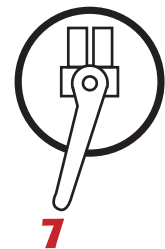
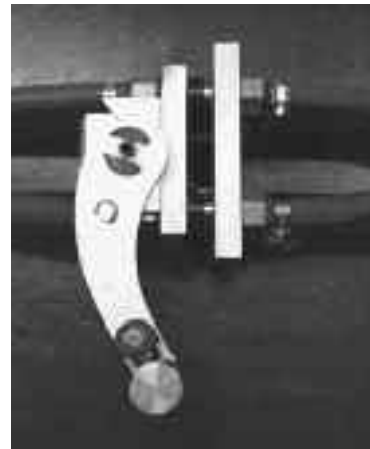

3. Pull red locking trigger and handle moves easily in a downward position from an 11 o'clock starting position to a 7 o'clock finishing position. The handle will be locked in place once locking pins are fully engaged and mechanical click is heard.



Multi-Coupling Plates: GRE Series

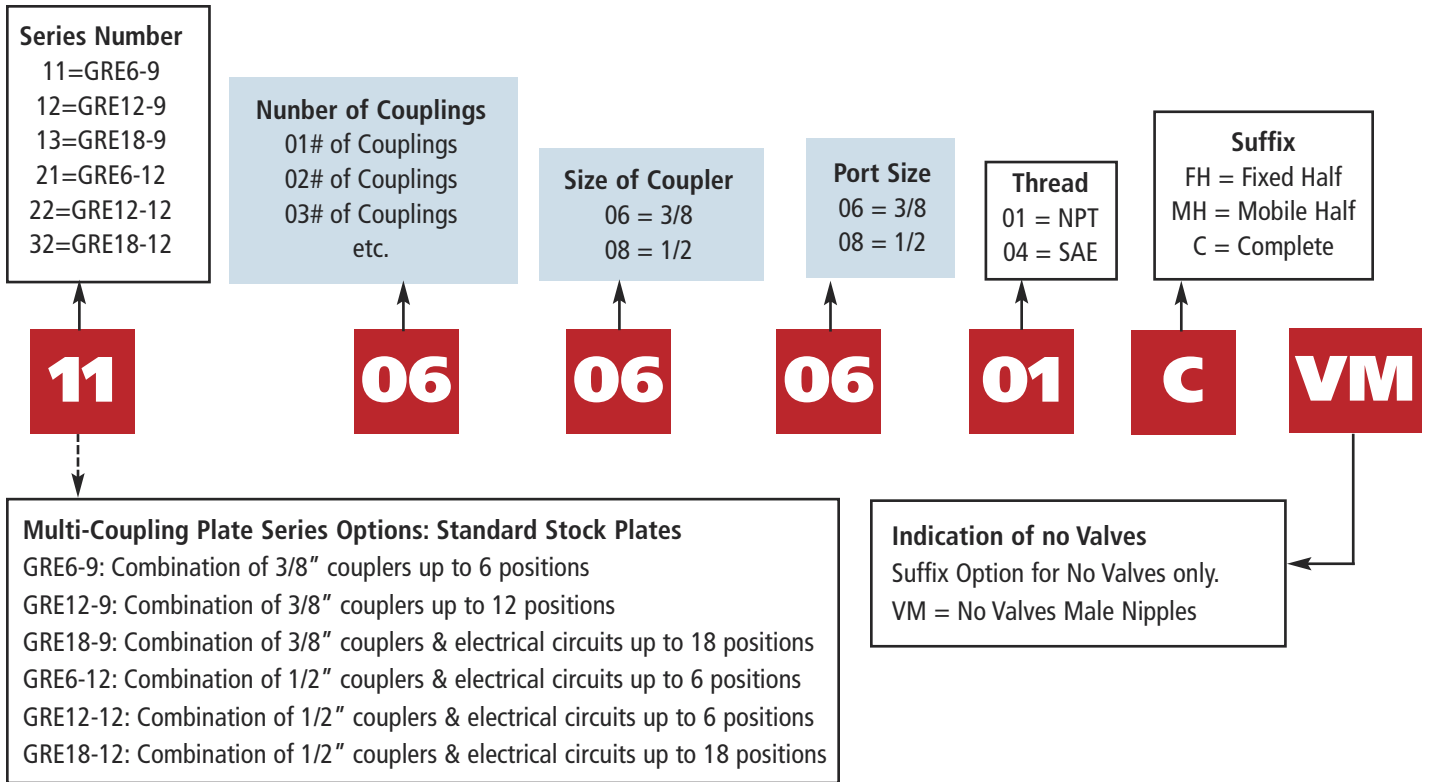

Common Stock Items

Stucchi Order Code	Description	# of Couplers	Coupler Size	Thread Size
110006060601C	GRE6-9(6) 3/8 NPT	6	3/8	3/8
120012060601C	GRE12-9(12) 3/8 NPT	12	3/8	3/8
130018060601C	GRE18-9(18) 3/8 NPT	18	3/8	3/8
210006080801C	GRE6-12(6) 1/2 NPT	6	1/2	1/2
220012080801C	GRE12-12(12) 1/2 NPT	12	1/2	1/2
230018080801C	GRE18-12(18) 1/2 NPT	18	1/2	1/2

The above list consists of the most popular stock items. Standard plates offer a variety of Standard Coupler combinations too broad to list in this catalog. Use the Stucchi Ordering Code System to create a Coupling Plate configuration for your application or fill out & fax the custom plate form for non-standard configurations.

GRE Series Replacement Couplers

Part	Body Size	Thread Size	Thread Type	Part Description
702123004M	3/8	3/8	NPT	F. CSF9BN
702123005L	3/8	3/8	NPT	M. CSM9BN
702123006M	1/2	1/2	NPT	F. CSF12BN
702123007L	1/2	1/2	NPT	M. CSM12BN



Parking Stations

Order Code	Description
815606033	Parking Station All Plates

Prices for plates and components available upon request

Series: Specialty Couplers



Series: Specialty Couplers Interchange: Stucchi Only

Specialty Couplers designed as solutions to customer applications

Replacement couplers for custom applications such as automation plates for cooling systems and hydraulics
Locomotive coolant systems, steel mill automation equipment

Type of fluids: cooling water (water and glycol, water and oil), hydraulic oil, grease

Main feature: Minimum spilling during disconnection & low air inclusion at connection. 90 degree transmission of the fluid. Connectable under low pressure for the oil version of CQB series.

Interchange: Stucchi Only Specialty Couplings: CQB Series

Part	Body Size	Port Size	Thread Type	Order Code	Part Description
Coupler	1/2	1/2	BSP	802000114	F. CQBF12 1/2 BSP
Nipple	1/2	1/2	BSP	802000115	M. CQBM12P 1/2 BSP
Coupler	3/4	3/4	BSP	802000116	F. CQBF20 3/4 BSP
Nipple	3/4	3/4	BSP	802000117	M. CQBM20 3/4 BSP
Coupler	2"	2"	BSP	802000130	F. CQBF45 2' BSP
Nipple	2"	2"	BSP	802000131	M. CQBM45 2' BSP
Coupler	2"	2 1/2"	BSP EXT	802000216	F. CQBF45E 2-1/2 BSP EST
Coupler	2 1/2"	3"	BSP EXT	802000220	F. CQBF60E 3' BSP EST
Nipple	2 1/2"	3"	BSP	802000223	M. CQBM60E 3' BSP
Coupler	2"	1 1/2"	BSP	802000226	F. CQLF45E 1-1/2 BSP
Nipple	2"	1 1/2"	BSP	802000227	M. CQLM45E 1-1/2 BSP
Coupler	2"	2 1/2"	BSP EXT	802000228	F. CQLF45E 2-1/2 BSP EST
Coupler	2"	2"	BSP EXT	802000232	F. CQLF45E 2' BSP EST
Nipple	2"	2"	BSP	802000233	M. CQLM45E 2' BSP
Coupler	2"	2"	BSP EXT	802000238	F. CQBF45E 2' BSP EST
Nipple	2"	1 1/2"	BSP-90	802050201	M. CQLM45E 1-1/2 BSP 90
Nipple	2 1/2"	3"	BSP-90	802050203	M. CQLM60E 3' BSP 90

Interchange: Stucchi Only Specialty Couplings: - FIRG SON

Part	Body Size	Port Size	Thread Type	Order Code	Part Description
Coupler	1/2	1/2	BSP	805700008	F. FIRG12A SON BSP
Nipple	1/2	1/2	BSP	805700009	M. FIRG12A SON BSP
Coupler	3/4	3/4	BSP	805700010	F. FIRG34B SON BSP
Nipple	3/4	3/4	BSP	805700011	M. FIRG34B SON BSP

Prices available upon request



Call us at 847-956-9720, Fax at 847-956-9723, or visit us on the web www.stucchiusa.com

Series: SSB, SSR

Series: SSB, SSR

Application: refilling cooling systems

Market: Refrigeration

Nominal Diameter: ISO 6.3

Max Operating Press. Coupled: 30 bar

Seals: HNBR

Type of fluid: Refrigeration fluids

Main feature: Interchangeable with other existing on the market.



Refrigeration Couplers Series: SSB, SSR

Part	Body Size	Port Size	Cap Color	Order Code	Part Description
Coupler	3/8	M14X1.5	Red	800262304	F SSR6 M14X1.5 90
Coupler	3/8	M14X1.5	Blue	800262306	F SSB6 M14X1.5 90

Prices available upon request

Protective Caps & Plugs



Series: PROTECTION PLUGS

These are useful accessories which prevent dust, water or mud from entering the quick couplings and lengthen their lives. This is particularly important in the building industry in general and in earth moving where large quantities of materials such as sand, earth, etc. are moved.

- Material: PVC/Rubber blend for flat face, and poppet series
- Material: Aluminum of IVHP, VP, VEP series
- Nylon Flip caps available on flat face
- Color: Red is standard with options for black, blue, yellow, green, etc.
- In the description, F is the designation for the "Coupler", M is the designation for "Nipple"

When choosing a cap please understand that the "F" in the description is for the female / Coupler half and the "M" is for the male / Nipple half of the set.

Flat Face Series: "A" & FIRG PVC CAPS - A8151

Stucchi Code	Stucchi Description	Coupler Cap Used With	Coupler Cap Used With
815100000	CAP F.A7	801301004	801304004
815100002	CAP F.A9 3/8 & CAP F.A9 1/2"	801301006 & 801301008	801304006 & 801304008
815100004	CAP F.A13 1/2"	801301010	803304004
815100006	CAP F.A13 3/4"	801301012	801304010
815100008	CAP F.A15	801301014	801304012
815100010	CAP F.A17	801301000	801304000
815100012	CAP F. A21	801301016	801304014

Stucchi Code	Stucchi Description	Nipple Cap Used With	Nipple Cap Used With
815100003	CAP M.A9 3/8"	801301005	801304005
815100005	CAP M.A9 1/2"	801301007	801304007
815100007	CAP M.A13 1/2"	801301009	801304035
815100009	CAP M.A13 3/4"	801301011	801304009
815100011	CAP M.A15	801301013	801304011
815100013	CAP M.A17	801301001	801304001
815100015	CAP M.A21	801301015	801304013



Call us at 847-956-9720, Fax at 847-956-9723, or visit us on the web www.stucchiusa.com

Protective Caps & Plugs

Stucchi Code	Stucchi Description	Coupler Cap Used With	Coupler Cap Used With
815100000	CAP F.FIRG 14	800801000	800804000
815100002	CAP F.FIRG 38 & CAP F.FIRG 12	800801004 & 800801002	800804002
815100004	CAP F.FIRG 12A	800801006	800804006
815100006	CAP F.FIRG 34	800801008	800804008
815100008	CAP F.FIRG 34B	800801010	800804010
815100010	CAP F.FIRG 100	800801012	800804012
815100012	CAP F. FIRG 114	800801014	800804014

Stucchi Code	Stucchi Description	Coupler Cap Used With	Coupler Cap Used With
815100001	CAP M.FIRG 14	800801001	800804001
815100003	CAP M. FIRG 38	800801005	
815100005	CAP M. FIRG 12	800801003	800804003
815100007	CAP M. FIRG 12A	800801007	800804007
815100009	CAP M. FIRG 34	800801009	800804009
815100011	CAP M. FIRG 34B	800801011	800804011
815100013	CAP M. FIRG 100	800801013	800804013

VP – Aluminum Caps

Stucchi Code	Stucchi Description	Coupler Cap Used With	Coupler Cap Used With
815300000	CAP F. VP 7	801901004	
815300002	CAP F. VP 9	801901010 & 801901000	807304020
815300004	CAP F. VP 13	801901006 & 801901008	807304022 & 807304008
815300006	CAP F. VP 15	801901002	807304010
815300008	CAP F. VP 17	801901012	807304012
815300010	CAP F. VP 21	801901014	807304014
815300012	CAP F. VP 30	801901016	807304016

Stucchi Code	Stucchi Description	Nipple Cap Used With	Nipple Cap Used With
815300001	CAP M. VP 7	801901005	
815300003	CAP M. VP 9	801901011 & 801901001	807304021
815300005	CAP M. VP 13	801901007 & 801901009	807304023 & 807304009
815300007	CAP M. VP 15	801901003	807304011
815300009	CAP M. VP 17	801901013	807304013
815300011	CAP M. VP 21	801901015	807304015
815300013	CAP M. VP 30	801901017	807304017

Protective Caps & Plugs

VEP – Aluminum Caps

Stucchi Code	Stucchi Description	Coupler Cap Used With	Coupler Cap Used With
815300030	CAP F. VEP 7	806501008	
815300032	CAP F. VEP 9	806501002 & 806501014	806504000
815300034	CAP F. VEP 13	806501000 & 806501016	806504004
815300036	CAP F. VEP 15	806501004	806504006
815300038	CAP F. VEP 17	806501006	806504002
815300040	CAP F. VEP 21	806501010	806504010
815300028	CAP F. VEP 30	806501012	806504012
815300042	CAP F. VEP 45	807201018	807204018

Stucchi Code	Stucchi Description	Coupler Cap Used With	Coupler Cap Used With
815300031	CAP M. VEP 7	806501009	
815300033	CAP M. VEP 9	806501003 & 806501015	806504001
815300035	CAP M. VEP 13	806501001 & 806501017	806504005
815300037	CAP M. VEP 15	806501005	806504007
815300039	CAP M. VEP 17	806501007	806504003
815300041	CAP M. VEP 21	806501011	806504011
815300029	CAP M. VEP 30	806501013	806504013
815300043	CAP M. VEP 45	807201019	807204019

ISO A – BIR Series Caps

Stucchi Code	Description	Nipple Cap Used With
815000012	CAP F.BIR 14	800501000
815000014	CAP F.BIR 38	800501002
815000004	CAP F.BIR 12	800001004
815000016	CAP F.BIR 34	800501006
815000018	CAP F.BIR 100	800501008

Stucchi Code	Description	Nipple Cap Used With
815000013	CAP M.BIR 14	800501001
815000015	CAP M.BIR 38	800501003
815000005	CAP M.BIR 12	800501005
815000017	CAP M.BIR 34	800501007
815000019	CAP M.BIR 100	800501009

Ag Series – IR PVC Caps

Stucchi Code	Description	Coupler Cap Used With
815000000	CAP F.IR 14	800001000
815000002	CAP F.IR 38	800001002
815000004	CAP F.IR 12	800001004
815000006	CAP F.IR 34	800001006
815000008	CAP F.IR 100	800001008

Stucchi Code	Description	Coupler Cap Used With
815000001	CAP M.IR 14	800001001
815000003	CAP M.IR 38	800001003
815000005	CAP M.IR 12	800001005
815000007	CAP M.IR 34	800001007
815000009	CAP M.IR 100	800001009



Call us at 847-956-9720, Fax at 847-956-9723, or visit us on the web www.stucchiusa.com

VEP Repair Kits

Order Code	Description
815700626	KIT F. VEP7P
815700627	KIT M. VEP7P
815700628	KIT F. VEP9P
815700629	KIT M. VEP9P
815700630	KIT F. VEP13P
815700631	KIT M. VEP13P
815700632	KIT F. VEP15P
815700633	KIT M. VEP15P
815700634	KIT F. VEP17P
815700635	KIT M. VEP17P
815700636	KIT F. VEP21P
815700637	KIT M. VEP21P
815700638	KIT F. VEP30P
815700639	KIT M. VEP30P
815700640	KIT F. VEP45P
815700641	KIT M. VEP45P

Repair Kits: BIR Series –ISO A Interchange

Order Code	Description
815700170	KIT F-BIR14
815700172	KIT F-BIR38
815700174	KIT F-BIR12
815700176	KIT F-BIR34
815700178	KIT F-BIR100
815700180	KIT F-BIR114
815700182	KIT F-BIR112
815700184	KIT F-BIR200
815700177	KIT M/F-BIR34
815700179	KIT M/F-BIR100
815700181	KIT M/F-BIR114
815700183	KIT M/F-BIR112
815700185	KIT M/F-BIR200

Repair Kits: M. VEP O-Ring Kits

Order Code	Description
815700735	O-Ring KIT M. VEP7
815700736	O-Ring KIT M. VEP 9
815700737	O-Ring KIT M. VEP 13
815700738	O-Ring KIT M. VEP 15
815700739	O-Ring KIT M. VEP 17
815700740	O-Ring KIT M. VEP 21
815700741	O-Ring KIT M. VEP 30
815700728	O-Ring KIT M. VEP 45

"A" Premier Series Repair Kits

Order Code	Description
815700434	KIT F. A9
815700097	KIT M. A9
815700436	KIT F. A13
815700099	KIT M. A13
815700438	KIT F. A15
815700101	KIT M. A15
815700440	KIT F. A17
815700103	KIT M. A17
815700442	KIT F. A21
815700105	KIT M. A21
815700444	KIT F. A30
815700107	KIT M. A30

FIRG Series Repair Kits

Order Code	Description
815700000	KIT F. FIRG 14
815700001	KIT M. FIRG 14
815700002	KIT F. FIRG 38/12
815700003	KIT M. FIRG 38/12
815700004	KIT F. FIRG 12A/34
815700005	KIT M. FIRG 12A/34
815700006	KIT F. FIRG 34B
815700007	KIT M. FIRG 34B
815700008	KIT F. FIRG 100
815700009	KIT M. FIRG 100
815700010	KIT F. FIRG 114
815700011	KIT M. FIRG 114
815700012	KIT F. FIRG 112
815700013	KIT M. FIRG 112
815700014	KIT F. FIRG 200
815700015	KIT M. FIRG 200

Repair Kits: IRB Series –ISO B Interchange

Order Code	Description
815700202	KIT F-IRB18
815700204	KIT F-IRB14
815700206	KIT F-IRB38
815700208	KIT F-IRB12
815700210	KIT F-IRB34
815700212	KIT F-IRB100
815700211	KIT M/F-IRB34
815700213	KIT M/F-IRB100

Technical Data/Conversion Chart

Measurement	To Convert	Into	Multiply By
Pressure	MPa	bar	10
Pressure	PSI	bar	0.07
Temperature	°F	°C	subtract 32 & multiply by 5/9
Volume	m3	Liters	0.002
Volume	gallons (Imperial)	Liters	4.546
Volume	gallons (USA)	Liters	3.7853
Force	kgf	N (Newton)	9.80

Seal Material Temperature Ratings

Seal Compound	°Operating Temperature Celsius
NBR (Nitrile)	-20 +100
Vitron	-15 +180
EPDM (Etilene Propilene)	-40 +150
Fluorurosilicone	-50 +150
Silicone (Silicone)	-50 +150
HNBR	-20 +130
Neoprene	-40 +100
Kalrez	-25 +300
PTFE (Teflon)	-50 +180

Dimensions and Relative Rated Flows for ISO 7241-2

Coupling Size ISO 7241-2	Norminal Tube Dash n.	Norminal Tube (mm)	Rated Flow ISO 7241-4
5	-2	4	3
5	-3	5	3
6.3	-4	6	12
6.3	-5	8	12
10	-6	10	23
12.5	-8	12	45
12.5	-10	16	45
16	-12	20	74
16	-14	22	74
19	-16	25	100
20	-	-	106
25	-20	30	189
31.5	-24	38	288
40	-32	50	379
50	-	-	757



Stucchi

Interchange Guide

The following interchange guide is of the most popular interchanges Stucchi USA Inc. offers. Please contact a customer service representative for items not listed in the guide.

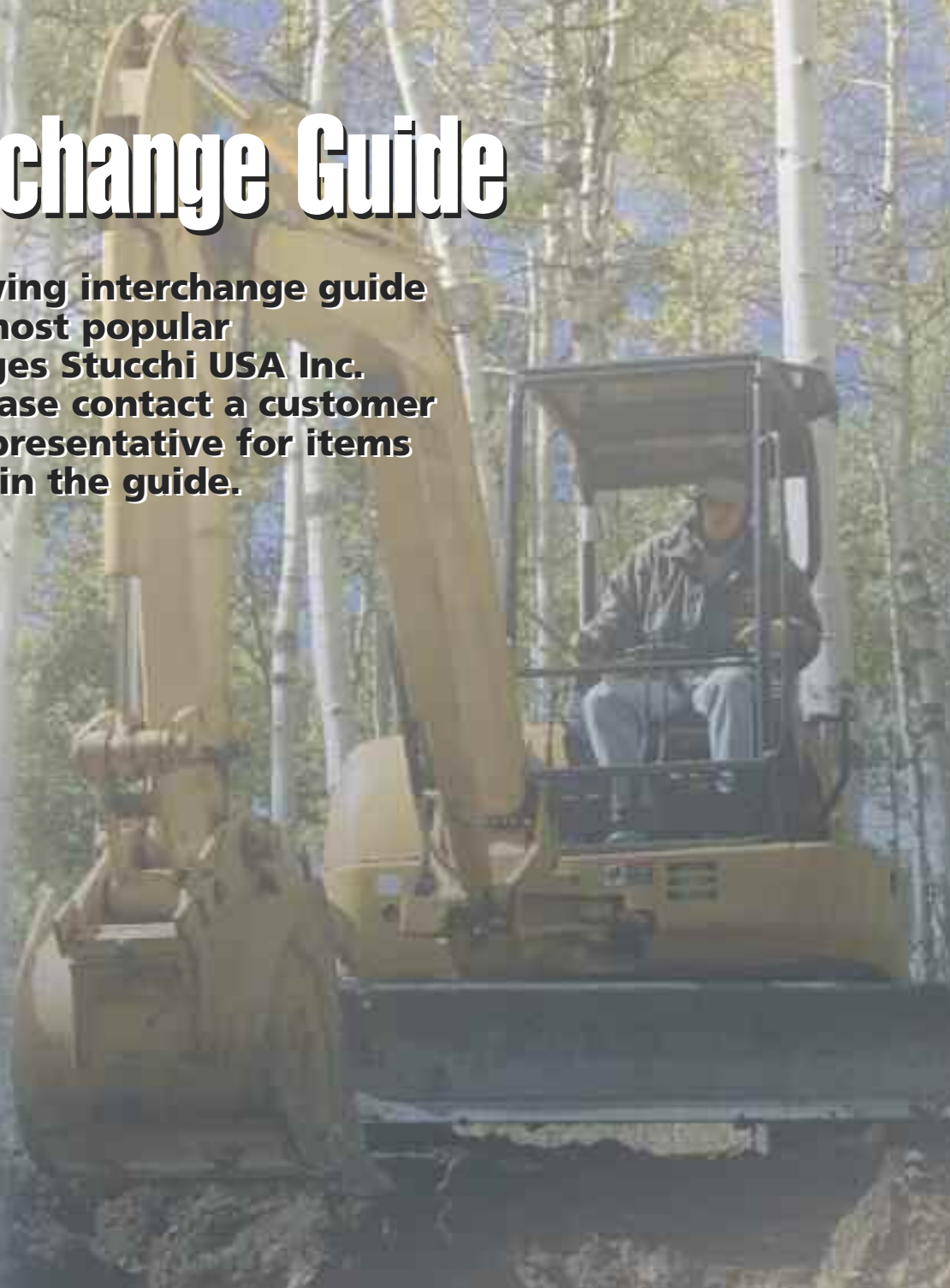

Order Code	Stucchi	Aeroquip	Faster	Hansen	Parker	Perfecting	Safeway	Snap-Tite	Tomco
Page 41	Male / Nipple								
804601101	M.IR BX 18 NPT					H1F1-S	SS-101-1		TK1-11-303
804601103	M.IR BX 14 NPT	FD45-1004-04-04	HNV-14-NPT-M-2	ML2-K16	SSH2-63	H2F2-S	SS-101-2	S72N4-4	TK2-16-303
804601105	M.IR BX 38 NPT	FD45-1004-06-06	HNV-38-NPT-M-2	ML3-K21	SSH3-63	H3F3-S	SS-101-3	S72N6-6	TK3-21-303
804601107	M.IR BX 12 NPT	FD45-1004-08-10	HNV-12-NPT-M-2	ML4-K26	SSH4-63	H4F4-S	SS-101-4	S72N8-8	TK4-26-303
804601109	M.IR BX 34 NPT	FD45-1004-12-12	HNV-34-NPT-M-2	ML6-K31	SSH6-63	H6F6-S	SS-101-6	S72N12-12	TK6-31-303
804601111	M.IR BX 100 NPT	FD45-1004-16-16	HNV-1-NPT-M-2	ML8-K36	SSH8-63	H8F8-S	SS-101-8	S72N16-16	TK8-36-303
Page 40	*ISO B Brass Female / Socket								
804501100	F.IR BOV 18 NPT					1HF1-B	BS-105-1		TH1-11-002
804501102	F.IR BOV 14 NPT	FD45-1101-04-04	HNV-14-NPT-F-5	B2-H16	BH2-60	2HF2-B	BS-105-2	B72C4-4	TH2-16-002
804501104	F.IR BOV 38 NPT	FD45-1101-06-06	HNV-38-NPT-F-5	B3-H21	BH3-60	3HF3-B	BS-105-3	B72C6-6	TH3-21-002
804501106	F.IR BOV 12 NPT	FD45-1101-08-10	HNV-12-NPT-F-5	B4-H26	BH4-60	4HF4-B	BS-105-4	B72C8-8	TH4-26-002
804501108	F.IR BOV 34 NPT	FD45-1101-12-12	HNV-34-NPT-F-5	B6-H31	BH6-60	6HF6-B	BS-105-6	B72C12-12	TH6-31-002
804501110	F.IR BOV 100 NPT	FD45-1101-16-16	HNV-1-NPT-F-5	B8-H36	BH8-60	8HF8-B	BS-105-8	B72C16-16	TH8-36-002
Page 40	Male / Nipple								
804501101	M.IR BOV 18 NPT				H1F1-B		BS-101-1		TK1-11-002
804501103	M.IR BOV 14 NPT	FD45-1086-04-04	HNV-14-NPT-M-5	B2-K16	BH2-61	H2F2-B	BS-101-2	B72N4-4	TK2-16-002
804501105	M.IR BOV 38 NPT	FD45-1086-06-06	HNV-38-NPT-M-5	B3-K21	BH3-61	H3F3-B	BS-101-3	B72N6-6	TK3-21-002
804501107	M.IR BOV 12 NPT	FD45-1086-08-10	HNV-12-NPT-M-5	B4-K26	BH4-61	H4F4-B	BS-101-4	B72N8-8	TK4-26-002
804501109	M.IR BOV 34 NPT	FD45-1086-12-12	HNV-34-NPT-M-5	B6-K31	BH6-61	H6F6-B	BS-101-6	B72N12-12	TK6-31-002
804501111	M.IR BOV 100 NPT	FD45-1086-16-16	HNV-1-NPT-M-5	B8-K36	BH8-61	H8F8-B	BS-101-8	B72N16-16	TK8-36-002
Page 16	ISO 16028 Interchangeable Female / Socket								
800801000	F. FIR G 14 NPT	FD89-1001-04-04	2FFI-14-NPT-F	6FFS25	FEM-251-4FP	2HG2	FFE495-2	74C 4-4F	EC2-16
800801004	F. FIR G 38 NPT	FD49-1001-06-06	2FFN-38-NPT-F	10FFS37	FF-371-6FP	3HGF3 / 3HTF3	FFE495-3	74C-6-6F	EC3-21
800801002	F. FIR G 12 NPT	FD49-1001-08-06	2FFN-38-12-NPT-F	10FFS50	FF-371-8FP	3HGF4 / 3HTF4	FFE495-3-8	74C-6-8F	EC3-26
800801006	F. FIR G 12A NPT	FD89-1001-08-08	2FFI-12-NPT-F	12FFS50	FEM-501-8FP	4HGF4 / 4HTF4	FFE495-4	74C 8-8F	EC4-26
800801008	F. FIR G 34 NPT	FD89-1001-12-08	2FFI-12-34-NPT-F	12FFS75		4HTF6	FFE495-4-3/4	74C 8-12F	EC4-31
800801010	F. FIR G 34B NPT	FD89-1001-12-12	2FFI-58-34-NPT-F	16FFS75		5HTF6		74C10-12F	EC6-31
800801020	F. FIR G 34A NPT		2FFI-34-NPT-F	19FFS75	FEM-751-12FP	6HTF6	FFE-495-6	74C12-12F	
800801012	F. FIR G 100 NPT	FD89-1001-16-16	2FFI-34-1-NPT-F	19FFS100		6HTF8	FFE-495-6-1	74C12-16F	EC8-36
800801014	F. FIR G 114 NPT	FD89-1001-20-20		25FFS125		8HTF10	FFE495-8-114	74C16-20F	
800801016	F. FIR G 112 NPT	FD89-1001-24-24	FFI 112 NPT M			12HGF12			
800801018	F. FIR G 200 NPT	FD89-1001-32-32	2FFI2-NPT-F			16HGF16			
Page 16	Male / Nipple								
800801001	M. FIR G 14 NPT	FD89-1002-04-04	2FFI-14-NPT-M	6FFP25	FEM-252-4FP	HG2F2	FFE491-2	74N 4-4F	EP2-16
800801005	M. FIR G 38 NPT	FD49-1002-06-06	2FFN-38-NPT-M	10FFP37	FF-372-6FP	HG3F3 / HT3F3	FFE491-3	74N-6-6F	EP3-21

Order Code	Stucchi	Aeroquip	Faster	Hansen	Parker	Perfecting	Safeway	Snap-Tite	Tomco
800801003	M. FIRG 12 NPT	FD49-1002-08-06	2FFN-38-12-NPT-M	10FFP50	FF-372-8FP	HG3F4 / HT3F4	FFE491-3-8	74N-6-8F	EP3-26
800801007	M. FIRG 12A NPT	FD89-1002-08-08	2FFI-12-NPT-M	12FFP50	FEM-502-8FP	HG4F4 / HT4F4	FFE491-4	74N 8-8F	EP4-26
800801009	M. FIRG 34 NPT	FD89-1002-12-08	2FFI-12-34-NPT-M	12FFP75		HT4F6	FFE491-4-3/4	74N 8-12F	EP4-31
800801011	M. FIRG 34B NPT	FD89-1002-12-12	FFI-58-34-NPT-M	16FFP75		HG5F6 / HT5F6		74N10-12F	EP6-31
800801021	M. FIRG 34A NPT		FFI-34-NPT-M	19FFP75	FEM-752-12FP	HT8F6	FFE-491-6	74N12-12F	
800801013	M. FIRG 100 NPT	FD89-1002-16-16	FFI-34-1-NPT-M	19FFP100		HT8F8	FFE-491-6-1	74N12-16F	EP8-36
800801015	M. FIRG 114 NPT	FD89-1002-20-20		25FFP125		HT8F10	FFE-491-8-114	74N16-20F	
800801017	M. FIRG 112 NPT	FD89-1002-24-24	FFI 112 NPT M			HG12F12			
800801019	M. FIRG 200 NPT	FD89-1002-32-32	FFI 2 NPT M			HG16F16			
	ISO 16028								
	Interchangeable								
	Female / Socket								
Page 16									
800804000	F.FIRG 14 3/8" SAE	FD89-1005-06-04	2FFI-14-38-SAE-F		FEM-251-6FO		FFE495-2-6	74C 4-6EF	
800804002	F.FIRG 38 1/2" SAE	FD89-1005-08-06	2FFI-38-12-SAE-F		FEM-371-8FO	3 HTOF4	FFE495-3-8	74C-6-8EF	EC3-8
800804004	F.FIRG 12 5/8" SAE	FD89-1005-10-06							
800804006	F.FIRG 12A 5/8" SAE	FD89-1005-10-08				4HTOF5		74C-8-10EF	
800804008	F.FIRG 34 SAE	FD89-1005-12-08	2FFI-12-34-SAE-F	12FFS106UN	FEM-501-12FO	4HTOF6	FFE495-4-12	74C-8-12EF	EC4-12
800804010	F.FIRG 34B SAE	FD89-1005-12-12	2FFI-58-34-SAE-F		FEM-621-12FO	5HTOF6		74C-10-12EF	
800804020	F.FIRG 34A SAE		2FFI 34-34-SAE-M		FEM-751-12FO	6HTOF6		74C12-12EF	
800804012	F.FIRG 100 SAE	FD89-1005-16-16	2FFI 34-1-SAE-M			6HTOF8	FFE-495-6-16	74C12-16EF	
Page 16	Male / Nipple								
800804001	M.FIRG 14 3/8" SAE	FD89-1004-06-04	2FFI-14-38-SAE-F		FEM-252-6FO		FFE491-2-6	74N 4-6EF	
800804003	M.FIRG 38 1/2" SAE	FD89-1004-08-06	2FFI-38-12-SAE-F		FEM-372-8FO	HT3OF4	FFE491-3-8	74N-6-8EF	EP3-8
800804005	M.FIRG 12 5/8" SAE	FD89-1004-10-06							
800804007	M.FIRG 12A 5/8" SAE	FD89-1004-10-08				HT4OF5		74N-8-10EF	
800804009	M.FIRG 34 SAE	FD89-1004-12-08	2FFI-12-34-SAE-F	12FFP106UN	FEM-502-12FO	HT4OF6	FFE491-4-12	74N-8-12EF	EP4-12
800804011	M.FIRG 34B SAE	FD89-1004-12-12	FFI-58-34-SAE-F		FEM-622-12FO	HT5OF6		74N-10-12EF	
800804021	M.FIRG 34A SAE		FFI 34-34-SAE-M		FEM-752-12FO	HT6OF6		74N12-12EF	
800804013	M.FIRG 100 SAE	FD89-1004-16-16	FFI 34-1-SAE-M			HT6OF8	FFE-491-6-16	74N12-16EF	
	ISO 16028								
	Interchangeable								
	Female / Socket								
Page 8									
801301002	F. A4 1/8 NPT								
801301004	F. A7 1/4 NPT	FD89-1001-04-04	2FFI-14-NPT-F	6FFS25	FEM-251-4FP		FFE495-2	74C4-4F	EC2-16
801301006	F. A9 3/8 NPT	FD89-1001-06-06	2FFN-38-NPT-F	10FFS37	FEM-371-6FP	3HTF3	FFE495-3	74C6-6F	EC3-21
801301008	F. A9 1/2 NPT	FD89-1001-08-06	2FFN-38-12-NPT-F	10FFS50		3HTF4	FFE495-3-8	74C6-8F	EC3-26
801301010	F. A13 1/2 NPT	FD89-1001-08-08	2FFI-12-NPT-F	12FFS50	FEM-501-8FP	4HTF4	FFE495-4	74C8-8F	EC4-26
801301012	F. A13 3/4 NPT	FD89-1001-12-08	2FFI-12-34-NPT-F	12FFS75		4HTF6	FFE495-4-3/4	74C8-12F	EC4-31
801301014	F. A15 3/4 NPT	FD89-1001-12-12	2FFI-58-34-NPT-F	16FFS75		5HTF6		74C10-12F	EC6-31
801301000	F. A17 1" NPT	FD89-1001-16-16	2FF-34-1-NPT-F	19FFS100		6HTF8	FFE-495-6-1	74C12-16F	EC8-36
801301030	F. A17 3/4" NPT		2FFI-34-NPT-F	19FFS75	FEM-751-12FP	6HTF6	FFE-495-6	74C12-12F	

Order Code	Stucchi	Aeroquip	Faster	Hansen	Parker	Perfecting	Safeway	Snap-Tite	Tomco
801301028	F. A21 1" NPT		2FFI-1-NPT-F		FEM-1001-16FP	8HTF8	FFE-495-8	74C16-16F	
801301016	F. A21 1/4 NPT			25FFS125		8HTF10	FFE-495-8-114		
801301018	F. A30 1/2 NPT					12HTF10			
Page 8	Male / Nipple								
801301003	M. A4 1/8 NPT								
800801001	M. FIRG 14 NPT	FD89-1002-04-04	2FFI-14-NPT-M	6FFP25	FEM-252-4FP		FFE491-2	74N4-4F	
801301005	M. A9 3/8 NPT	FD89-1002-06-06	FFN-38-NPT-MU	10FFP37	FEM-372-6FP	HT3F3	FFE491-3	74N6-6F	EP3-21
801301007	M. A9 1/2 NPT	FD89-1002-08-06	FFN-38-12-NPT-MU	10FFP50		HT3F4	FFE491-3-8	74N6-8F	
801301009	M. A13 1/2 NPT	FD89-1002-08-08	FFI-12-NPT-M	12FFP50	FEM-502-8FP	HT4F4	FFE491-4	74N8-8F	EP4-26
801301011	M. A13 3/4 NPT	FD89-1002-12-08	FFI-12-34-NPT-M	12FFP75		HT4F6	FFE491-4-3/4	74N8-12F	EP4-31
801301013	M. A15 3/4 NPT	FD89-1002-12-12	FFI-58-34-NPT-M	16FFP75		HG5F6 / HT5F6		74N-10-12F	EP6-31
801301001	M. A17 1" NPT	FD89-1002-16-16	FF-34-1-NPT-M	19FFP100	FEM-752-12FP	HT6F8	FFE-491-6-1	74N12-16F	EP8-36
801301031	M. A17 3/4" NPT		FFI-34-NPT-M	19FFP75		HT6F6	FFE-491-6	74N12-12F	
801301029	M. A21 1" NPT		FFI-1-NPT-M		FEM-1002-16FP	HT8F8	FFE-491-8	74N16-16F	
801301015	M. A21 1/4 NPT			25FFP125		HT8F10	FFE-491-8-114		
801301017	M. A30 1/2 NPT					HT12F12			
Page 9	ISO 16028								
	Interchangeable								
	Female / Socket								
801304002	F.A4 3/16 SAE								
801304004	F.A7 3/8 SAE	FD89-1005-06-04	2FFI-14-38-SAE-F		FEM-251-6FO		FFE495-2-6		
801304006	F.A9 3/8 SAE		2FFN-38-38-SAE-F			3HTOF3		74C 6-6EF	
801304008	F.A9 1/2 SAE	FD89-1005-08-06	2FFN-38-12-SAE-F		FEM-371-8FO	3HTOF4	FFE495-3-8	74C-6-8EF	EC3-8
801304030	F.A9 5/8 SAE	FD89-1005-10-06							
803304004	F.A13 1/2 SAE		2FFI-12-12-SAE-F			4HTOF4			
803304002	F.A13 5/8 SAE	FD89-1005-10-08	2FFI-12-58-SAE-F		FEM-501-10FO	4HTOF5		74C-8-10EF	
801304010	F.A13 3/4 SAE	FD89-1005-12-08	2FFI-12-34-SAE-F	12FFS106UN	FEM-501-12FO	4HTOF6	FFE495-4-12	74C-8-12EF	EC4-12
801304012	F.A15 3/4 SAE	FD89-1005-12-12	2FFI-58-34-SAE-F		FEM-621-12FO	5HTOF6		74C10-12EF	
801304028	F.A17 3/4 SAE		2FFI-34-34-SAE-F		FEM-721-12FO	6HTOF6		74C12-12EF	
801304000	F.A17 1" SAE	FD89-1005-16-16	2FFI-34-1-SAE-F			6HTOF8	FFE495-6-16	74C12-16EF	
801304038	F.A21 1" SAE		2FFI-1-1-SAE-F		FEM-1001-16FO	8HTOF8	FFE-495-8-20	74C16-16EF	
Page 9	Male / Nipple								
801304003	M.A4 3/16 SAE								
800804001	M.FIRG 14 3/8 SAE	FD89-1004-06-04	2FFI-14-38-SAE-M		FEM-252-6FO		FFE491-2-6	74N4-6EF	
801304005	M.A9 3/8 SAE		2FFN-38-38-SAE-M			HT3OF3		74N6-6EF	
801304007	M.A9 1/2 SAE	FD89-1004-08-06	2FFN-38-12-SAE-M		FEM-372-8FO	HT3OF4	FFE491-3-8	74N-6-8-EF	EP3-8
801304031	M.A9 5/8 SAE	FD89-1004-10-06							
801304035	M.A13 1/2 SAE		2FFI-12-12-SAE-M			HT4OF4		74N8-8EF	
801304025	M.A13 5/8 SAE	FD89-1004-10-08	2FFI-12-58-SAE-M		FEM-502-10FO	HT4OF5		74N8-10EF	
801304009	M.A13 3/4 SAE	FD89-1004-12-08	2FFI-12-34-SAE-M	12FFP106UN	FEM-502-12FO	HT4OF6	FFE491-4-12	74N8-12EF	EP4-12
801304011	M.A15 3/4 SAE	FD89-1004-12-12	FFI-58-34-SAE-M		FEM-622-12FO	HT5OF6		74N10-12EF	

Order Code	Stucchi	Aeroquip	Faster	Hansen	Parker	Perfecting	Safeway	Snap-Tite	Tomco
801304029	M.A17 3/4 SAE		FFI-34-34-SAE-M		FEM-722-12FO	HT60F6		74C12-12EF	
801304000	M.A17 1" SAE	FD89-1004-16-16	FFI-34-1-SAE-M			HT60F8	FFE491-6-16	74C12-1EF	
801304039	M.A21 1" SAE		FFI-1-1-SAE-M		FEM-1002-16FO	HT80F8	FFE-491-8-20	74N16-1EF	
Page 19	ISO 16028								
805201001	Connect Under Pressure M.APM 9 3/8 NPT		3FFI-38 NPT M						
805201003	M.APM 9 1/2 NPT		3FFI-38-12N M						
805201005	M.APM 13 1/2 NPT		3FFI-12-NPT-M		FEC-502-8FP			CP74N8-8F	
805201007	M.APM 13 3/4 NPT		3FFI-12-34-N-M						
805201009	M.APM 15 3/4 NPT		3FFI-58-34-N-M						
805201011	M.APM 17 1" NPT		3FFI-34-1-N-M						
805201017	M.APM 21 114 NPT		3FFI-1-114-N-M		FEC-1001				
805201015	M.APM 30 112 NPT								
Page 19									
805204001	M.APM 9 1/2 SAE		3FFI-38-12-SAE-M						
805204003	M.APM 13 5/8 SAE		3FFI-12-58-SAE-M		FEC-502-10FO			CP74N8-10EF	
805204005	M.APM 13 3/4 SAE		3FFI-12-34-SAE-M		FEC-502-12FO			CP74N8-12EF	
805204007	M.APM 15 3/4 SAE		3FFI-58-34-SAE-M		FEC-622-12FO				
805204009	M.APM 17 1" SAE		3FFI-34-1-S-M		FEC-752				
805204017	M.APM 21 114 SAE		3FFI-1-114-SAE-M		FEC-1001				
805204015	M.APM 30 112 SAE								
Page 47	Enerpac Interchange								
800201008	Female / Socket F. IVHP 14 NPT		PVVM 1/14-NPT-F		3050-2	2TM2	S35-2		JC2-15
800201004	F. IVHP 38 NPT		PVVM 1/38-NPT-F		3050-3	3TF3	S35-3		JC3-20
800201009	Male / Nipple M. IVHP 14 NPT		PVVM-14-NPT-M		3010-2	T2M2	S31-2		JP2-16
800201005	M. IVHP 38 NPT		PVVM-38-NPT-M		3010-3	T3F3	S31-3		JP3-21
Page 44	Ag -Poppet Interchange								
800101000	Female / Socket F. IRV 14 NPT	FD42-1001-04-04	NV-14-NPT-F		4050-2P	2AGF2-PV	S25A-2P	60C4-4F	C2-16
800101002	F. IRV 38 NPT		NV-38-NPT-F		4050-3P	3AGF3-PV	S25-3P	60C6-6F	C3-21
800501004	F. BIR 12 NPT	G5601-8-10	NV-12-NPT-F		4050-4P	4AGF4-PV	S25-4P		C4-26
800101004	F. IRV 34 NPT		NV-34-NPT-F*		4050-5P	6AGF6-PV	S25F-6P		C6-31
800101006	F. IRV 100 NPT		NV-1-NPT-F		4050-6P	8AGF8-PV	S25-8P		C8-36
Page 44	Male / Nipple								
800101001	M. IRV 14 NPT	FD42-1002-04-04	NV-14-NPT-M		4010-2P	AG2F2-PV	S41-2P	60N4-4F	P2-16
800101003	M. IRV 38 NPT		NV-38-NPT-M		4010-3P	AG3F3-PV	S41-3P	60N6-6F	P3-21
800501005	M. BIR 12 NPT	G5602-8-10	NV-12-NPT-M		8010-4P	AG4F4-PV	S71-4P		P4-26
800101005	M. IRV 34 NPT		NV-34-NPT-M*		4010-5P	AG6F6-PV	S21F-6P		P6-31

Order Code	Stucchi	Aeroquip	Faster	Hansen	Parker	Perfecting	Safeway	Snap-Tite	Tomco
800101007	M. IRV 100 NPT		NV-1-NPT-M		4010-6P	AG8F8-PV	S21-8P		P8-36
	*FA Version needed to interchange								
	Ag -Ball Valve Interchangeable Female / Socket								
Page 45									
800001000	F. IR 14 NPT		NS-14-NPT-F		4050-2	2AGF2	S25A-2		
800001002	F. IR 38 NPT		NS-38-NPT-F		4050-3	3AGF3	S25-3		
800001004	F. IR 12 NPT		NS-12-NPT-F		4050-4	4AGF4	S25-4		
800001006	F. IR 34 NPT		NS-34-NPT-F		4150-5	6AGF6	S25F-6		
800001008	F. IR 100 NPT		NS-1-NPT-F			8AGF8	S25-8		
Page 45	Male / Nipple								
800001001	M. IR 14 NPT		NS-14-NPT-M		4010-2	AG2F2	S41-2		
800001003	M. IR 38 NPT		NS-38-NPT-M		4010-3	AG3F3	S41-3		
800001005	M. IR 12 NPT		NS-12-NPT-M		8010-4	AG4F4	S71-4		
800001007	M. IR 34 NPT		NS-34-NPT-M*		4110-5	AG6F6	S21F-6		
800001009	M. IR 100 NPT		NS-1-NPT-M			AG8F8	S21-8		
	*FA Version needed to interchange								
	Ag Push/Pull Interchangeable Female/Socket								
Page 44-45									
800401002	F. IRS 12 VA NPT				4250-4P		S45-4P		
800301002	F. IRS 12A NPT				4250-4		S45-4		
800401004	F. IRS12VA PC NPT				8250-4		S75-4		
	Wing Style Interchangeable Female / Socket								
Page 46									
100610012	F. W6F6-B	5100-S5-12B	FB-12/34-NPT-F-5	96-S31	6125-12	6WF6-B	S515W-6	B78C-12-12-F	51W-12
100610016	F. 8WF8-B	5100-S5-16B	FB-16/1-NPT-F-5	96-S36	6125-16	8WF-B	S515W-8	B78C-16-16-F	51W-16
100610020	F. 10WF10-B	5100-S5-20B	FB-20/114-NPT-F-5	96-S41	6125-20	10WF10-B	S515W-10	B78C-20-20-F	51W-20
Page 46	Female / Socket								
100610112	M. W6F6-B	5100-S2-12B	FB-12/34-NPT-M-5	96-P31	6105-12	W6F6-B	S511W-6	B78N-12-12-F	51P-12
100610116	M. W8F8-B	5100-S2-16B	FB-16/1-NPT-M-5	96-P36	6105-16	W8F8-B	S511W-8	B78N-16-16-F	51P-16
100610120	M. W10F10-B	5100-S2-20B	FB-20/114-NPT-M-5	96-P41	6105-20	W10F10-B	S511W-10	B78N-20-20-F	51P-20

ISO 16028 Coupler ID Chart

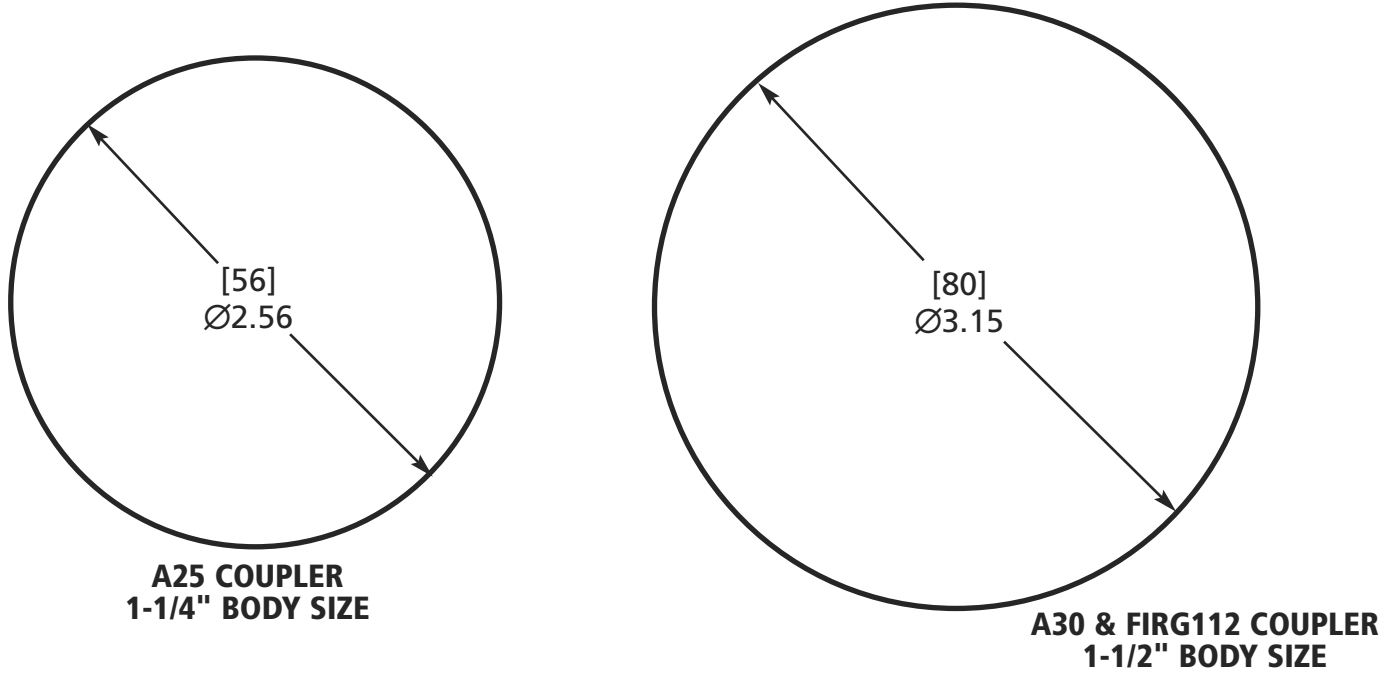
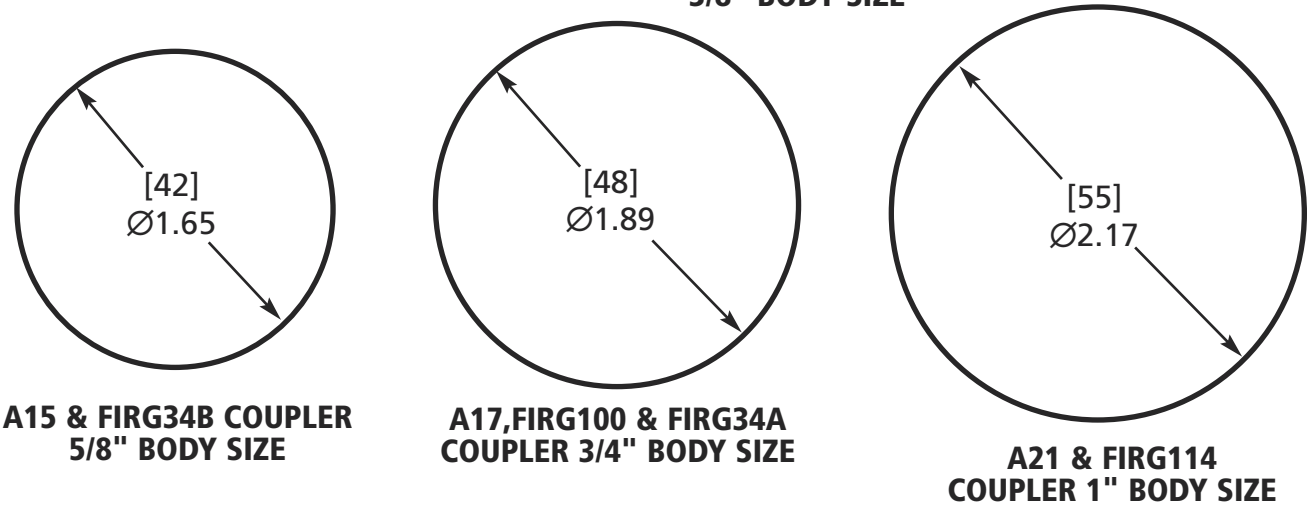
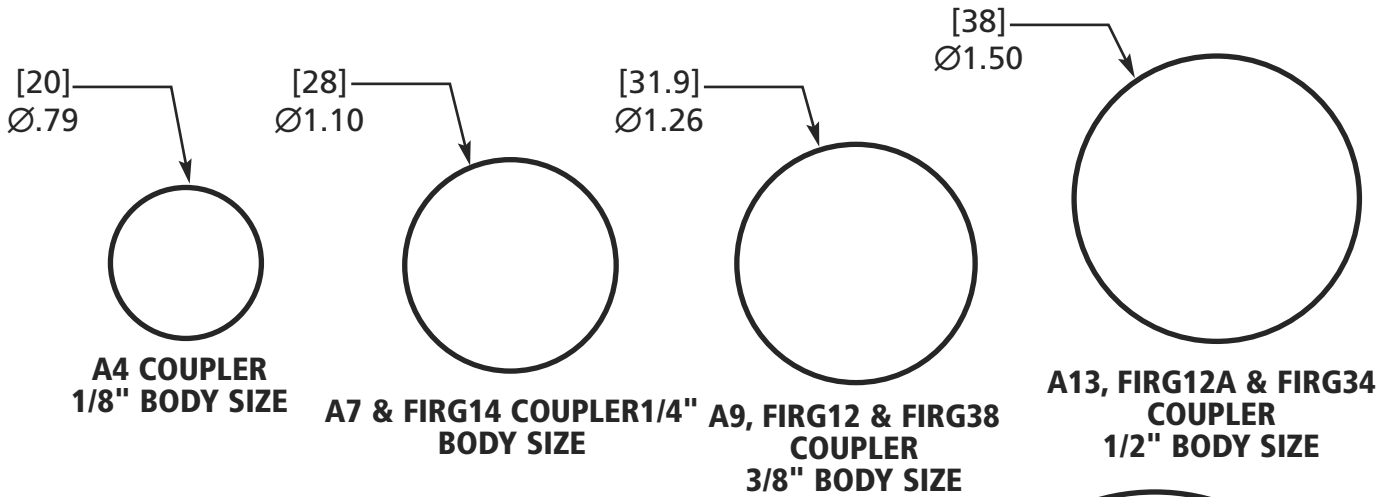

VIEWED FROM PORT END OF FEMALE COUPLER

ISO 16028 Nipple ID Chart

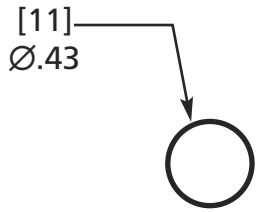

**A4 NIPPLE
1/8" BODY SIZE**

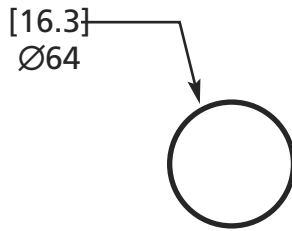

**A7 & FIRG114 NIPPLE
1/4" BODY SIZE**

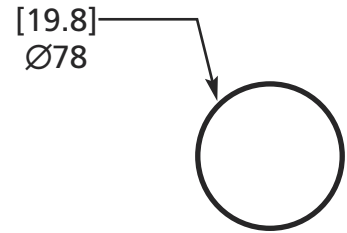

**A9, FIRG12 & FIRG38
NIPPLE 3/8" BODY SIZE**

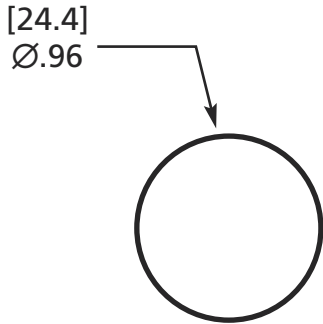

**A13, FIRG12A & FIRG 34
NIPPLE 1/2" BODY SIZE**

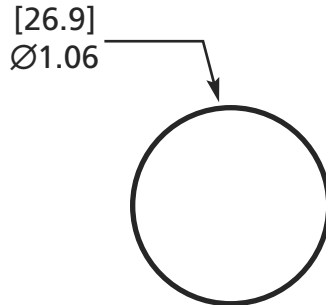

**A15 & FIRG34B
NIPPLE 5/8" BODY SIZE**

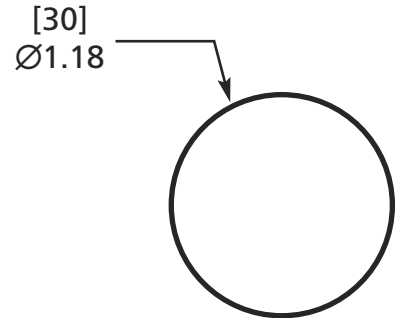

**A17, FIRG34A & FIRG 100
NIPPLE 3/4" BODY SIZE**

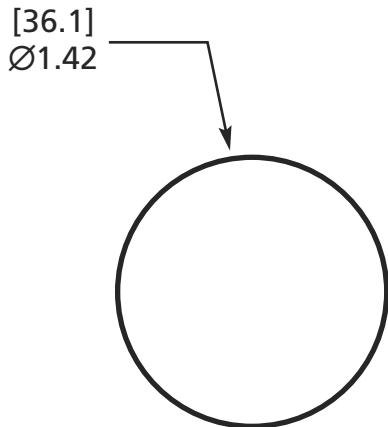

**A21 & FIRG 114
NIPPLE 1" BODY SIZE**

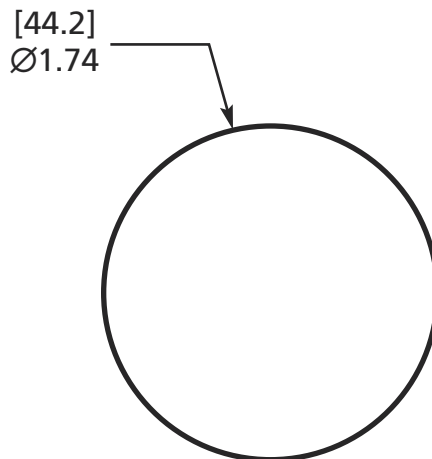

**A25 NIPPLE
1-1/4" BODY SIZE**

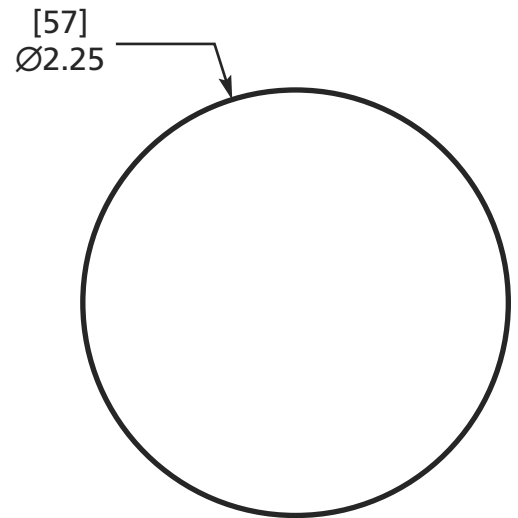

**A30 & FIRG 112 NIPPLE
1-1/2" BODY SIZE**

VIEWED FROM PORT END OF MALE COUPLER

Technical Data/Conversion Chart

Company Name: _____

Date:

Submitted by: _____

Operative Features

Technical Data

Interchangeability:

Type of Fluid:

Application Area:

Nominal Diameter:

Agriculture

Earth Moving

Flow-L/minute:

Industrial

Automation

Type of Coupling Male Female Coupled

Other:

Working Pressure:

Burst Pressure:

Working Temp.:

Impulse Frequency:

Single coupling

Hydrostaitc Pressure:

Multiple connections:

Seals:

of Couplings for Multiple connect system:

Nitrile

Silicone

Connection force w/out residual pressure:

Neoprene

EPDM

Environmental conditions of applic.:

Viton

Other:

Pressure Drop:

Type of Coupling:

Ball Type Sealing Valve/Poppet Push-Pull

Quantity/Volume of Parts:

Flat-Face Clamping ball system

Other

Working Cycles

Weight Applied to Female Half:

Assembly Frequency:

Weight Applied to Male Half:

Residual Internal pressure Male Half:

Residual Internal Pressure Female Half:



Stucchi

Unlock The Solution

Stucchi USA Inc.

**1107 Windham Parkway
Romeoville, IL 60446 USA**

Tel. (847) 956-9720

Fax: (847) 956-9723

www.stucchiusa.com

